

**reflex**

*pininfarina*

HOME DESIGN



*pininfarina*

HOME DESIGN



**INDICE**  
*index*

5	PININFARINA SEGNO SOFA COLLECTION
31	PININFARINA COLLECTION
55	COORDINAMENTO STILISTICO / <i>style coordination</i>
89	MATERIALI E FINITURE / <i>materials &amp; finishes</i>



## SEGNO COLLECTION

Pininfarina Segno è un sistema integrato di Living parte del progetto Reflex/Pininfarina Home Design.

Pininfarina Home Design rappresenta un viaggio per esplorare scenari fino ad oggi ignoti. Un viaggio nell'Ambiente Casa, nel quale sono stati uniti per la prima volta l'heritage Pininfarina nel furniture design con l'innovativo stile architettonico e d'interni della design house italiana. Per immaginare e realizzare soluzioni d'interni con un carattere unico, essenziale e distintivo, nel quale la progettazione dello spazio si sposi naturalmente con la personalità degli arredi. Per dare vita ad esperienze nelle quali l'estetica e la funzione si integrano. Per dare forma a degli spazi pensati per lo stile di vita contemporaneo.

Un viaggio fatto di design, innovazione, sartorialità, lusso, stile italiano. Un viaggio per suscitare emozione e creare valore.

Pininfarina Segno – un sistema integrato di Living Reflex e Pininfarina presentano in anteprima il primo sistema integrato di Living, che include un divano componibile in diverse soluzioni, un tavolo, un cabinet, una libreria e due sistemi di illuminazione. La Collezione è caratterizzata da linee pure ed eleganti, da forme dinamiche che evolvendo nello spazio danno vita a nuove funzioni. L'utilizzo del rame è un ulteriore trait d'union che, combinato al noce canaletto, conferisce un carattere unico e distintivo alla Collezione.

*Pininfarina Segno is an integrated Living system, part of the Reflex/Pininfarina Home Design project.*

*Pininfarina Home Design represents a journey in exploring new scenarios. A journey into the Home Space in which, for the first time, Pininfarina's heritage in furniture was combined with the innovative style in architecture and interiors of the Italian design house. To imagine and realize solutions for interiors with a unique and distinctive character, in which the design of the space naturally marries the personality of the furniture. To give life to experiences in which form and function are integrated. To give shape to spaces conceived for a contemporary lifestyle. A journey made of design, innovation, custom-tailoring, luxury, Italian style. A journey to raise emotion and to create value.*

*Pininfarina Segno – an integrated Living system Reflex and Pininfarina present in preview the first integrated Living system, that includes a modular sofa, a table, a cabinet, a bookcase and two lighting systems. The Collection is characterized by pure and elegant lines, by dynamic shapes that evolving in the space give shape to new functions. The use of copper is a further trait d'union that, combined with the walnut Canaletto wood, confer a unique and distinctive character to the Collection.*

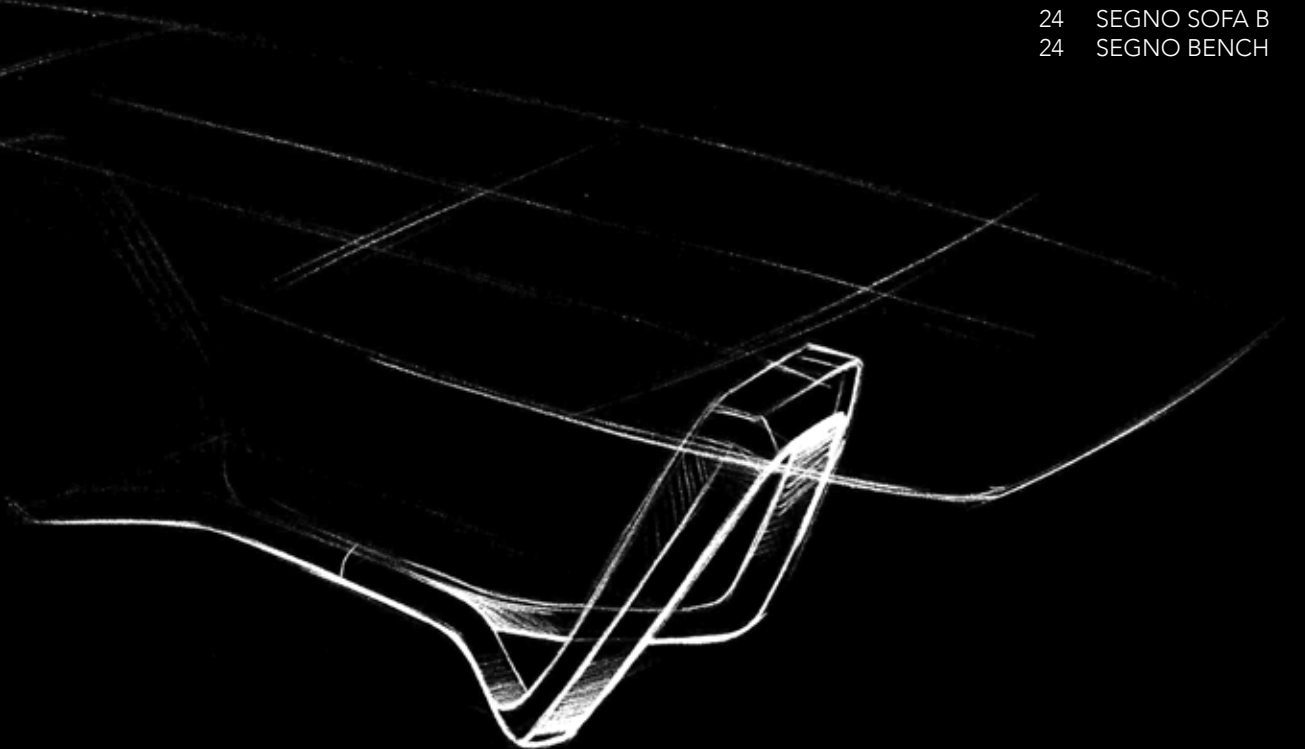

**PININFARINA SEGNO SOFA  
COLLECTION**  
*index*

- 
- 7 SEGNO CHAISE LONGUE B
  - 8 SEGNO HAISE LONGUE A
  - 12 SEGNO SOFA WOOD A
  - 14 SEGNO SOFA WOOD D
  - 15 SEGNO SOFA WOOD E
  - 18 SEGNO SOFA WOOD B
  - 19 SEGNO SOFA WOOD C
  - 22 SEGNO SOFA A
  - 24 SEGNO SOFA B
  - 24 SEGNO BENCH





## SEGNO SOFA CHAISE LONGUE B

Disegno Pininfarina

Divano con struttura in legno con imbottitura in poliuretano espanso rivestita. Cuscini di seduta in poliuretano indeformabile. Cuscini di schienale in piuma d'oca con inserto in poliuretano. Rivestimento in pelle, tessuto o velluto. Piattaforma in Rovere Henné, Rovere Miele o in Noce Canaletto. Chaise longue imbottita rivestita in pelle trapuntata. Piedini in finitura Titanium.

Versione angolare disponibile destra o sinistra con 4 cuscini e 1 bracciolo.

*Sofa with wooden structure padded with polyurethane foam and upholstered. Seat cushions in crushproof polyurethane. Back cushions in goose feather with polyurethane insert. Upholstery available in fabric, velvet or leather. Platform in Oakwood Henné, Oakwood Miele or in Canaletto Walnut. Padded chaise-longue upholstered with quilted leather. Legs in Titanium finishing. Corner version available left or right with 4 cushions and 1 arm.*

In foto / On image:

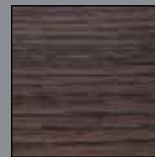
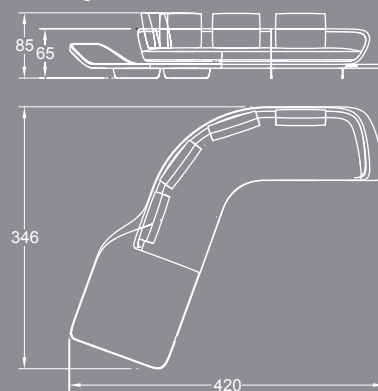

STRUTTURA /  
STRUCTURE  
Rovere /  
Oakwood Henné

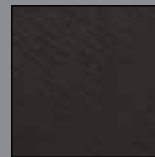

CHAISE LONGUE  
Pelle/Leather  
Testa di moro

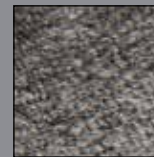

RIVESTIMENTO /  
UPHOLSTERY  
Tessuto/Fabric  
Luxury Regent  
street - ash gray  
05







## SEGNO SOFA CHAISE LONGUE A

Disegno Pininfarina

Divano con struttura in legno con imbottitura in poliuretano espanso rivestita. Cuscini di seduta in poliuretano indeformabile. Cuscini di schienale in piuma d'oca con inserto in poliuretano. Rivestimento in pelle, tessuto o velluto. Piattaforma in Rovere Henné, Rovere Miele o in Noce Canaletto. Chaise longue imbottita rivestita in pelle trapuntata. Piedini in finitura Titanium. Versione dritta con 2 cuscini e 1 bracciolo destro o sinistro.

*Sofa with wooden structure padded with polyurethane foam and upholstered. Seat cushions in crushproof polyurethane. Back cushions in goose feather with polyurethane insert. Upholstery available in fabric, velvet or leather. Platform in Oakwood Henné, Oakwood Miele or in Canaletto Walnut. Padded chaise-longue upholstered with quilted leather. Legs in Titanium finishing. Straight version with 2 cushions and 1 left or right arm.*

In foto / On image:



Rovere /  
Oakwood Miele



CHAISE LONGUE  
Pelle/Leather Blu  
Grafite 145

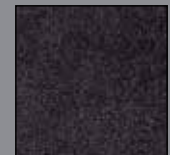

RIVESTIMENTO /  
UPHOLSTERY  
Velluto/Velvet  
Grafite 163 G



1. Struttura Rovere Henné, Chaise-longue pelle Testa di Moro 123, rivestimento tessuto Luxury Regent Street 05 , 4 cuscini 45x45 pelle Henné 118, 2 cuscini 45x45 tessuto Luxury Regent Street 05 e 2 cuscini 26x37 tessuto Luxury Regent Street 07 / Structure Oakwood Henné, Chaise-longue leather Testa di Moro 123, upholstery fabric Luxury Regent Street 05, 4 pillows 45x45 leather Henné 118, 2 pillows 45x45 fabric Luxury Regent Street 05, 2 pillows 26x37 fabric Luxury Regent Street 07

2. Chaise-Longue pelle Henné 118, rivestimento tessuto Luxury Regent Street 04, cuscino 45x45 tessuto Luxury Bond's Street 01, cuscino 26x37 pelle Talpa 124 / Chaise-Longue leather Henné 118, upholstery fabric Luxury Regent Street 04, pillow 45x45 fabric Luxury Bond's Street 01, pillow 26x37 leather Talpa 124

3. Chaise-Longue pelle Henné 118, rivestimento tessuto Extra Via Spiga 02, cuscino 45x45 pelle Crema 110, cuscino 26x37 velluto Titanio 151V / Chaise-Longue leather Henné 118, upholstery fabric Extra Via Spiga 02, pillow 45x45 leather Crema 110, pillow 26x37 velvet Titanio 151V

4. Chaise-Longue pelle Henné 118, rivestimento tessuto Extra Via Spiga 06, cuscino 45x45 pelle Henné 118, cuscino 26x37 velluto Rosso 132G / Chaise-Longue leather Henné 118, upholstery fabric Extra Via Spiga 06, pillow 45x45 leather Henné 118, pillow 26x37 velvet Rosso 132G

Finiture disponibili a pagina 89 / Finishes on page 89

A destro

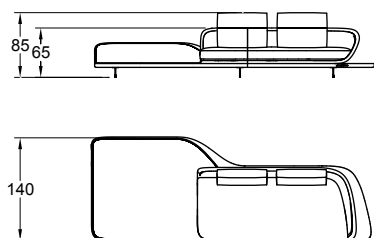

A sinistro

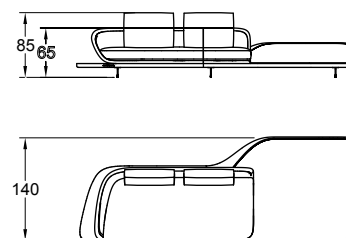

B destro

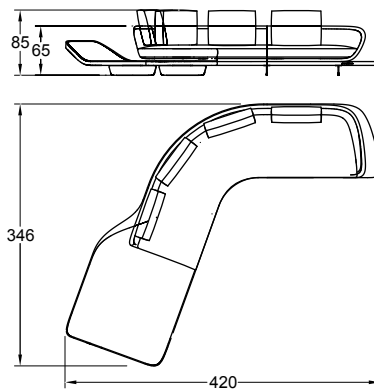

B sinistro

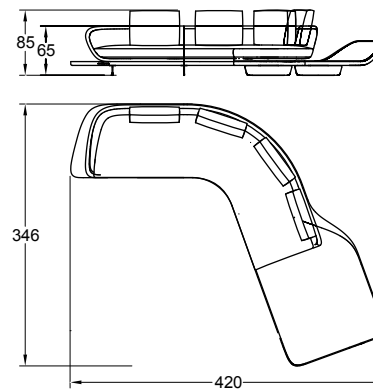





## SEGNO SOFA WOOD

Disegno Pininfarina

Divano con struttura in legno con imbottitura in poliuretano espanso rivestita. Cuscini di seduta in poliuretano indeformabile. Cuscini di schienale in piuma d'oca con inserto in poliuretano. Rivestimento in pelle, tessuto o velluto. Piattaforma in Rovere Henné, Rovere Miele o in Noce Canaletto. Piedini in finitura Titanium.

Disponibile con 1 bracciolo destro o sinistro con ripiano laterale rivestito in pelle trapuntata (modello A), con 2 braccioli (modello B), angolare con 3 cuscini e 1 bracciolo destro o sinistro (modello C), angolare con 4 cuscini e 2 braccioli (modello D), composizione a 3 cuscini e 2 braccioli con angolare rivestito in pelle trapuntata (modello E)

*Sofa with wooden structure padded with polyurethane foam and upholstered. Seat cushions in crushproof polyurethane. Back cushions in goose feather with polyurethane insert. Upholstery available in fabric, velvet or leather. Platform in Oakwood Henné, Oakwood Miele or in Canaletto Walnut. Legs in Titanium finishing.*

*Available with 1 left or right arm and side shelf upholstered with quilted leather (model A), with 2 arms (model B), corner with 3 cushions and 1 left or right arm (model C), corner with 4 cushions and 2 arms (model D), composition with 3 cushions and 2 arms and corner shelf upholstered with padded quilted leather (model E).*

In foto / On image:

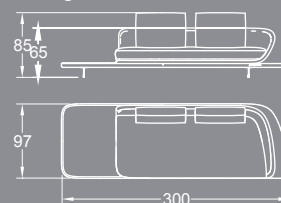

STRUTTURA /  
STRUCTURE  
Rovere /  
Oakwood Miele

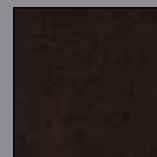

CHAISE LONGUE  
Nabuk Caffè 028

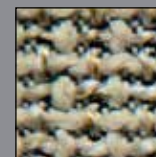

RIVESTIMENTO /  
UPHOLSTERY  
Tessuto/  
Fabric Extra -  
Montenapoleone  
01

In foto / On image:

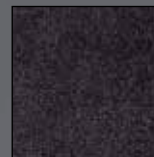
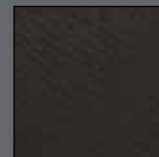
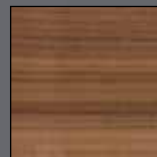

STRUTTURA /  
STRUCTURE  
Noce Canaletto /  
Canaletto walnut

CHAISE LONGUE  
pelle/leather  
Testa di moro

RIVESTIMENTO /  
UPHOLSTERY  
Velluto/Velvet  
Grafite 163 G



In foto / On image:

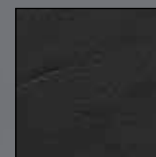
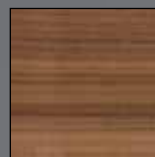

STRUTTURA /  
STRUCTURE  
Noce Canaletto /  
Canaletto walnut

SOFA 1  
Tessuto/  
Fabric Extra -  
Montenapoleone  
Characoal gray 07

SOFA 2  
pelle/leather  
Hennè





In foto / On image:

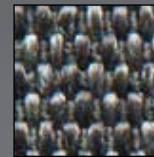
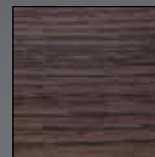

STRUTTURA /  
STRUCTURE

Rovere /  
Oakwood Henné

RIVESTIMENTO /  
UPHOLSTERY

Tessuto/Fabric  
Super - Via Spiga  
Dark gray

CUSCINI /  
PILLOWS

Tessuto/Fabric  
Luxury - Regent  
Street Light gray





1. Struttura Noce Canaletto, rivestimento tessuto Super Via Condotti 04, 4 cuscini 45x45 tessuto Luxury Bond's Street 02, 2 cuscini 26x37 pelle Ocra 136 / Structure Canaletto Walnut, upholstery fabric Super Via Condotti 04, 4 pillows 45x45 fabric Luxury Bond's Street 02, 2 pillows 26x37 leather Ocra 136
2. Struttura Rovere Henné, rivestimento velluto Oliva 137V, cuscino 45x45 tessuto Luxury Bond's Street 04, cuscino 26x37 velluto Visone 121V / Structure Oakwood Henné, upholstery velvet Oliva 137V, pillow 45x45 fabric Luxury Bond's Street 04, pillow 26x37 velvet Visone 121V
3. Struttura Rovere Henné, rivestimento velluto Visone 121V, cuscino 45x45 pelle Oliva 137, cuscino 26x37 velluto Oliva 137V / Structure Oakwood Henné, upholstery velvet Visone 121V, pillow 45x45 leather Oliva 137, pillow 26x37 velvet Oliva 137V
4. Struttura Rovere Henné, rivestimento tessuto Luxury Regent Street 04, cuscino 45x45 tessuto Extra Via Spiga 06, cuscino 26x37 tessuto Luxury Regent Street 04 / Structure Oakwood Henné, upholstery fabric Luxury Regent Street 04, pillow 45x45 fabric Extra Via Spiga 04, pillow 26x37 fabric Luxury Regent Street 04.

In foto / On image:



STRUTTURA /  
STRUCTURE  
Rovere /  
Oakwood Miele



RIVESTIMENTO /  
UPHOLSTERY  
Pelle/Leather  
Fumo



CUSCINI /  
PILLOWS  
Tessuto/Fabric  
Luxury - Bond's  
street sea shell 01



In foto / On image:



STRUTTURA /  
STRUCTURE  
Rovere /  
Oakwood Henné



RIVESTIMENTO  
/ UPHOLSTERY  
Tessuto/Fabric  
Super Via  
Condotti Ecrú 03

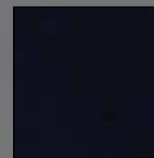

CUSCINI /  
PILLOWS  
Velluto/Velvet  
Ottanio 149 V





2.



3.



4.



1.

1. Struttura Rovere Henné, Chaise-Longue pelle Henné 118, rivestimento tessuto Extra Montenapoleone 04, 1 cuscino 26x37 pelle Rosso 132, 2 cuscini 45x45 e 1 cuscino 26x37 tessuto Super Via Condotti 12. / Structure Oakwood Henné, Chaise-longue leather Henné 118, upholstery fabric Extra Montenapoleone 04, 1 pillow 26x37 leather Rosso 132, 2 pillows 45x45 and 1 pillow 26x37 fabric Super Via Condotti 12.

2. Struttura Rovere Miele, Chaise-longue Nabuk Caffè 028, rivestimento tessuto Extra Via Spiga 03, 2 cuscini 45x45 e 1 cuscino 26x37 Nabuk Caffè 028, 2 cuscini 26x37 tessuto Extra Via Spiga 03. / Structure Oakwood Miele, Chaise-longue Nabuk Caffè 028, upholstery fabric Extra Via Spiga 03, 2 pillows 45x45 and 1 pillow 26x37 Nabuk Caffè 028, 2 pillows 26x37 fabric Extra Via Spiga 03.

3. Struttura Rovere Henné, Chaise-longue pelle Notte 143, rivestimento tessuto Luxury Bond's Street 01, 2 cuscini 45x45 e 1 cuscino 26x37 tessuto Luxury Bond's Street 01, 3 cuscini 26x37 pelle Notte 143. / Structure Oakwood Henné, Chaise-longue leather Notte 143, upholstery fabric Luxury Bond's Street 01, 2 pillows 45x45 e 1 pillow 26x37 fabric Luxury Bond's Street 01, 3 pillows 26x37 leather Notte 143.

4. Struttura Rovere Henné, Chaise-longue pelle Notte 143, rivestimento pelle Notte 143, 2 cuscini 45x45 e 1 cuscino 26x37 tessuto Luxury Bond's Street 01, 2 cuscini 26x37 pelle Notte 143. / Structure Oakwood Henné, Chaise-longue leather Notte 143, upholstery leather Notte 143, 2 pillows 45x45 e 1 pillow 26x37 fabric Luxury Bond's Street 01, 2 pillows 26x37 leather Notte 143.

Finiture disponibili a pagina 89 / Finishes on page 89

A destro

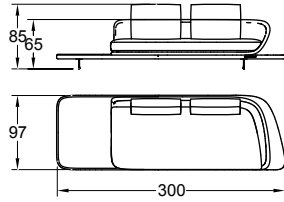

A sinistro

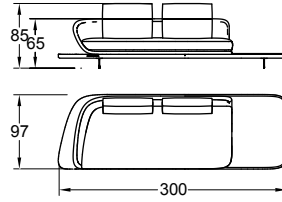

B

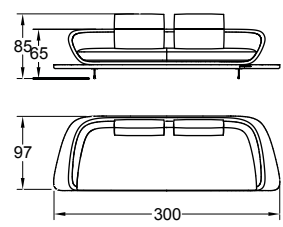

C destro

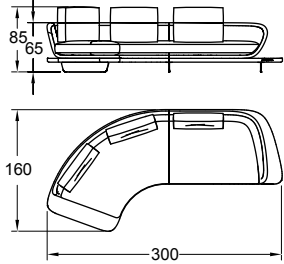

C sinistro

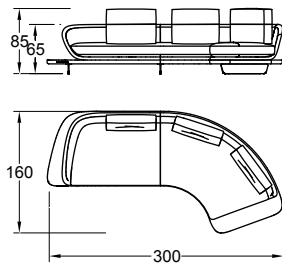

D destro

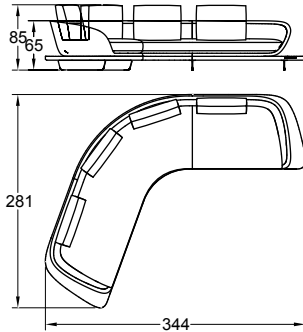

D sinistro

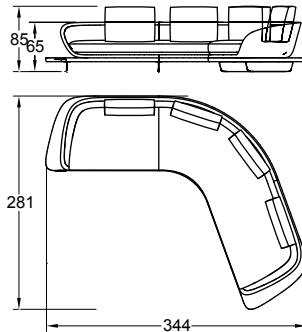

E destro

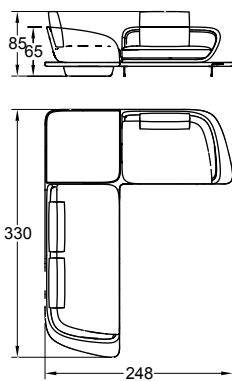

E sinistro

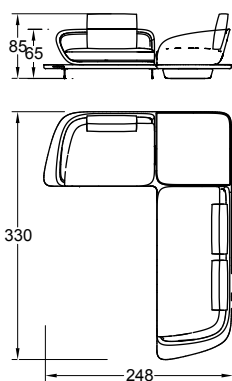



# SEGNO SOFA

Disegno Pininfarina

Divano con struttura in legno con imbottitura in poliuretano espanso rivestita. Cuscini di seduta in poliuretano indeformabile. Cuscini di schienale in piuma d'oca con inserto in poliuretano. Rivestimento in pelle, tessuto o velluto. Piedini in finitura Titanium. Disponibile con 1 bracciolo destro o sinistro (modello A) o con 2 braccioli (modello B).

*Sofa with wooden structure padded with polyurethane foam and upholstered. Seat cushions in crushproof polyurethane. Back cushions in goose feather with polyurethane insert. Upholstery available in fabric, velvet or leather. Legs in Titanium finishing.*

*Available with 1 left or right arm (model A) o con 2 braccioli (model B).*

In foto / On image:

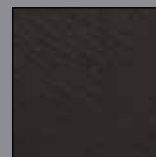
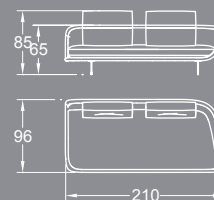

RIVESTIMENTO/  
UPHOLSTERY  
Pelle/Lather  
Caffè



SCHIENALE/  
SEATBACK  
Tessuto/Fabric  
Super Via  
Condotti Ecrù 03



CUSCINI/  
PILLOWS  
Extra - Via Spiga  
Coffee 04



In foto / On image:  
210 x 60 x 85h



STRUTTURA /  
STRUCTURE  
Rovere /  
Oakwood Héné

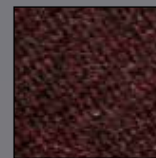

RIVESTIMENTO /  
UPHOLSTERY  
Tessuto/Fabric  
Luxury - Regent  
street Dark  
magenta 07



CUSCINI /  
PILLOWS  
Tessuto/Fabric  
Extra - Brera  
Antique ruby 05



Finiture disponibili a pagina 89 / Finishes on page 89

A destro

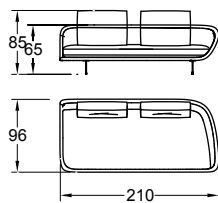

A sinistro

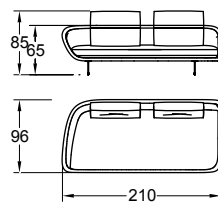

Accessori

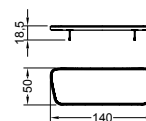

B

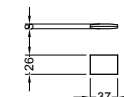
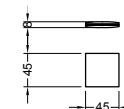
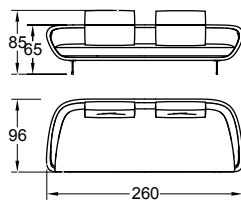

STRUTTURA / STRUCTURE



Rovere /  
Oakwood Henné



Rovere /  
Oakwood Miele

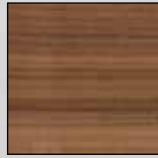

Noce Canaletto /  
Canaletto walnut

BASI / LEGS

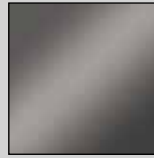

Titanium

CHAISE LONGUE



Pelle / Leather

IMBOTTITURA E CUSCINI / UPHOLSTERY AND PILLOWS



Tessuto / Fabric  
Pelle / Leather  
Velluto / Velvet

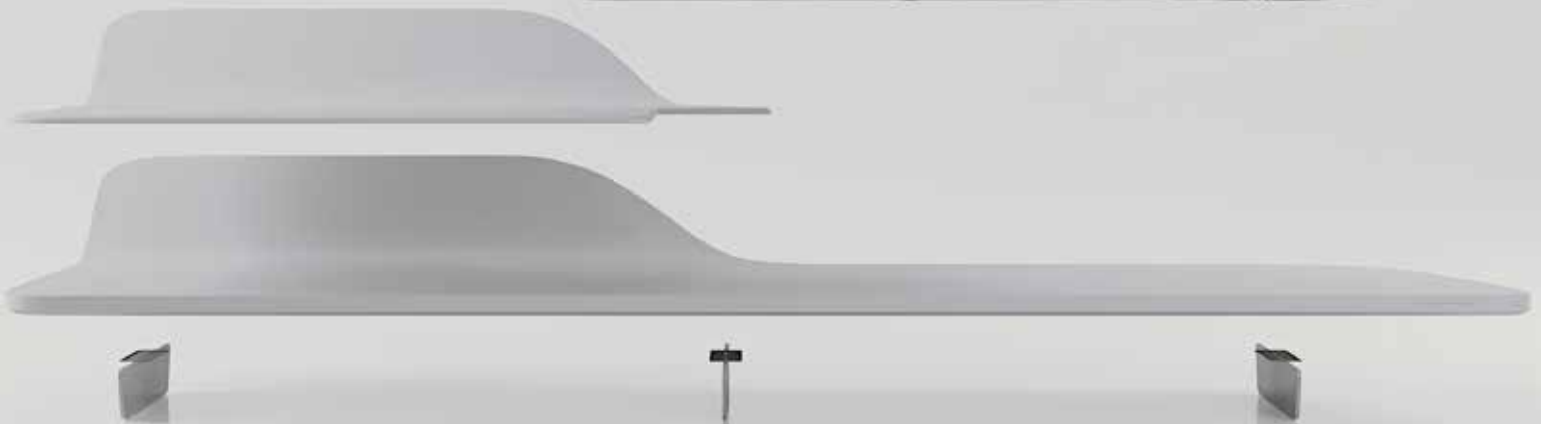

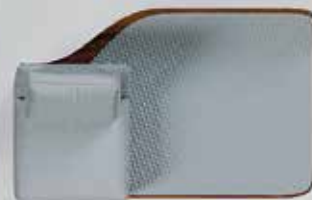
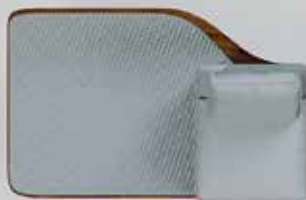

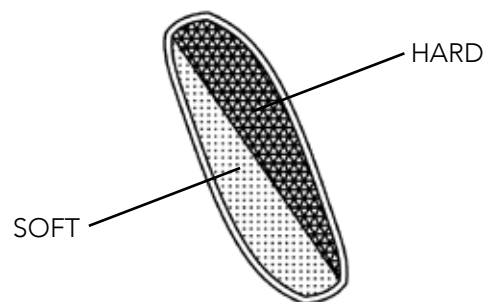

POSITION A - Relax

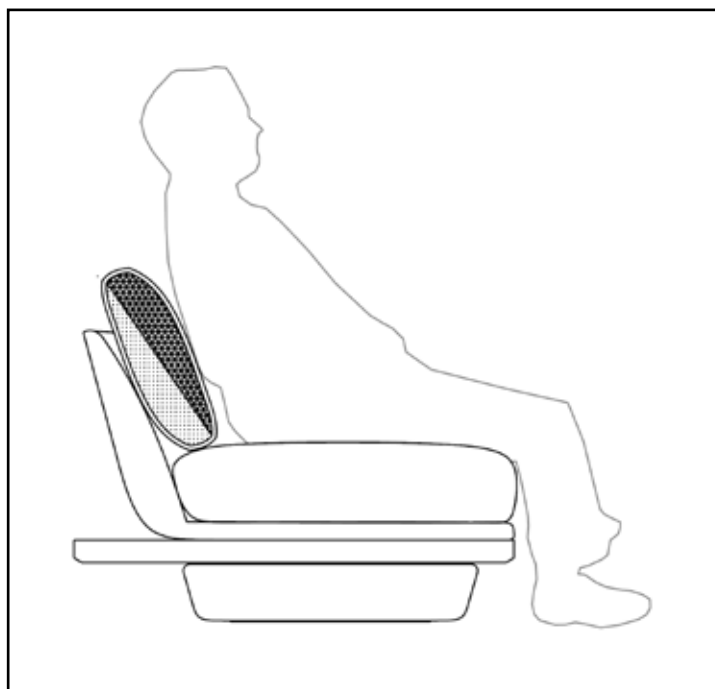

POSITION B - Sit

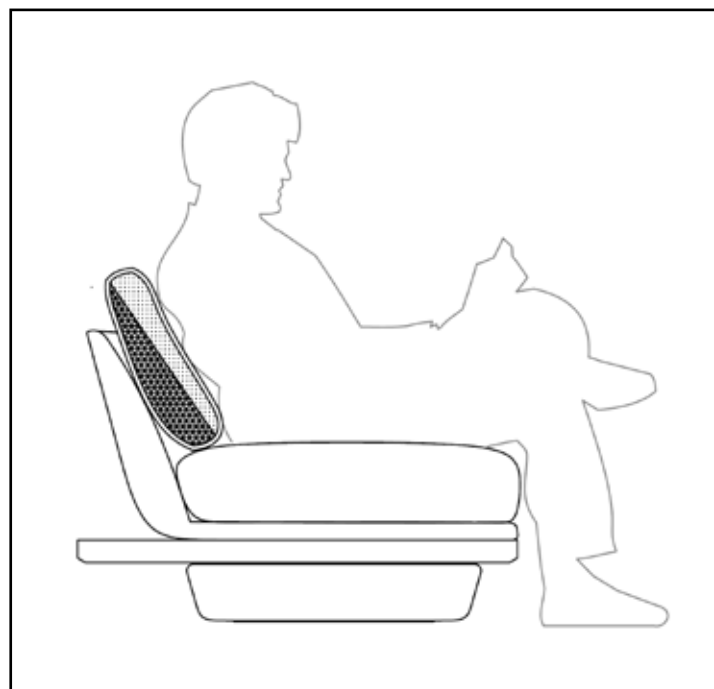

Cuscino di schienale **brevetto** Reflex costituito internamente da due strati differenti di portanza per garantire due livelli di confort diversi.

Reflex **Patent** back cushion internally composed by two lift layers to grant different comfort levels.

1.



2.



3.



4.



5.



6.



7.



8.



9.



10.



11.



12.





**PININFARINA COLLECTION**  
*index*

32	SEGNO TAVOLO
39	SEGNO LAMPADARIO
41	SPEEDFORM
43	VELA SEDIA
46	SIT SEDIA
49	SEGNO LIBRERIA
50	SEGNO BUFFET
52	SEGNO CREDENZA LOW



# SEGNO 72

Disegno Pininfarina

Tavolo pranzo con base in materiale composito rinforzato in metallo, in finitura laccato opaco o lucido colori Latte o Henné o in finitura rame o acciaio orbitale. Piano in cristallo trasparente o extrachiaro trasparente sp.15 mm filo lucido nella versione fissa o allungabile.

Disponibile anche con piano in legno di spessore 40mm con bordo rastremato 45° (Bevel Wood) in Rovere Henné o in finitura laccato opaco rivestito in vetro verniciato o acidato verniciato in vari colori.

*Dining table with base in mixed material with metal support in matt or shiny lacquered finish, Latte or Henné colour or in copper or steel orbital finishing. Top in transparent glass or extra clear transparent glass 15mm thick polished edges in fix or extendable version. Also available with wooden top 40mm th. with tapered edges 45° (Bevel Wood) in Oakwood Henné or in matt lacquered finish covered in lacquered or etched lacquered glass in various colours.*

In foto / On image:

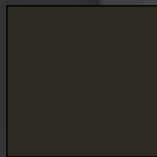
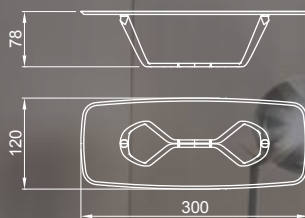

BASE  
laccato lucido  
Henné / Henné  
shiny lacquered

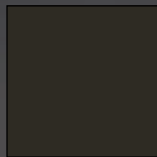

PIANO/TOP  
Bevel wood con  
vetro verniciato  
Henné / Bevel  
wood with henné  
lacquered glass









reflex

*pininfarina*

HOME DESIGN



BASE

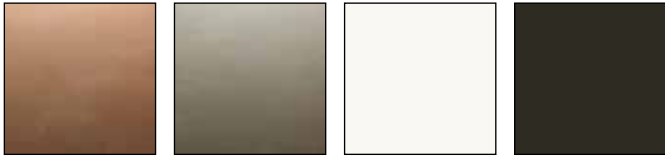

Rame / Copper

Acciaio / steel

Latte

Henné

PIANO / TOP



Extra

Latte

Henné

Noce Canaletto /  
Canaletto walnut

Rovere /  
Oakwood Henné

VETRO / GLASS

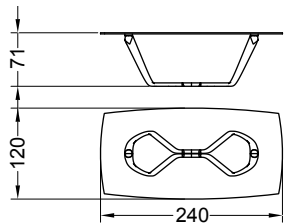
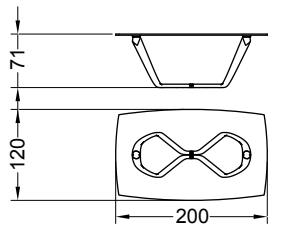
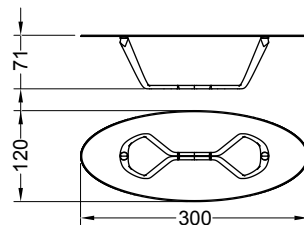
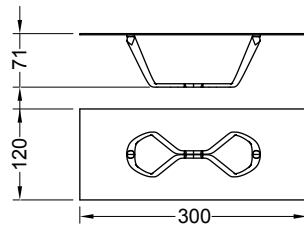
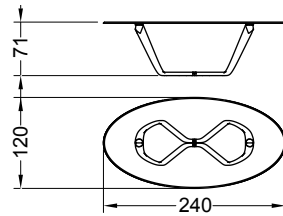
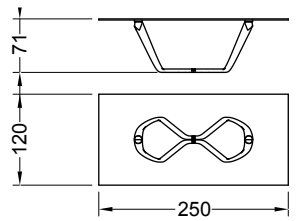

VETRO ALLUNGABILE / GLASS-EXTENSION

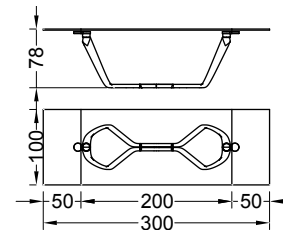
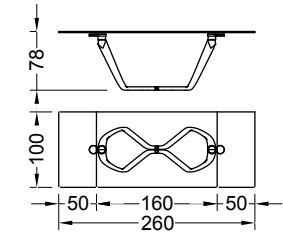
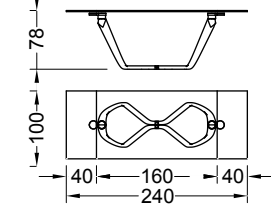

BEVEL WOOD

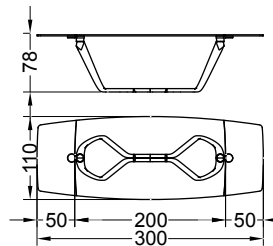
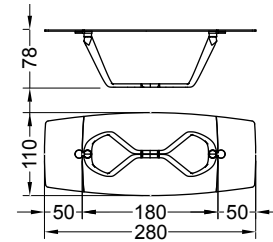
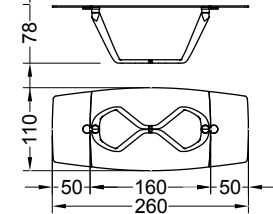
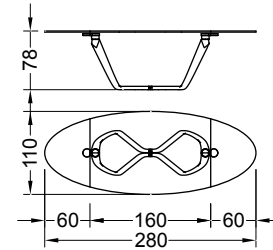
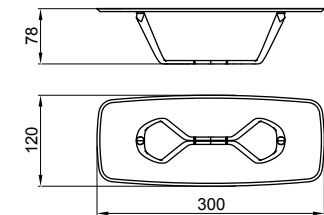
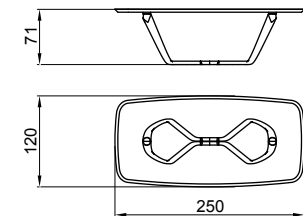
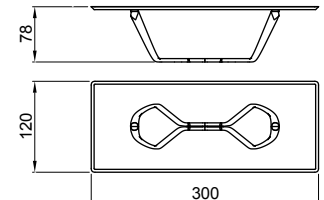
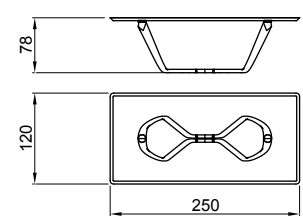



# SEGNO LAMPADARIO

Disegno Pininfarina

Lampadario con supporto in cristallo a specchio con LED incassati con 1 elemento curvato in acciaio lucido con interno in finitura rame con LED.  
Applique in acciaio lucido con interno finitura rame con LED.

*Suspended lamp with mirror support with built-in LED. Pendant curved element in shiny steel with internal copper finish and with LED.  
Wall lamp in shiny steel with internal copper finish with LED.*

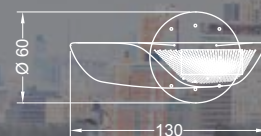
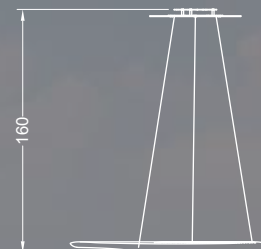





# SPEEDFORM

Disegno Pininfarina

Lampadario con supporto in cristallo a specchio. Disponibile a 1 o 2 elementi curvati in finitura laccato opaco o lucido colori Latte o Henné oppure in finitura rame o acciaio orbitale o ottone antico scuro. Illuminazione a LED sia sul supporto sia negli elementi

*Suspended lamp with mirror support. Available with 1 or 2 curved elements in matt or shiny lacquered Henné or Latte colours or in copper or steel orbital finish or in antiqued dark brass finish. LED lighting system on the support as well as on the elements.*

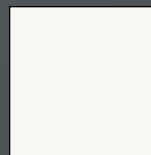
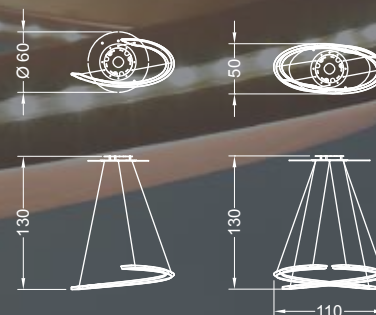

Latte

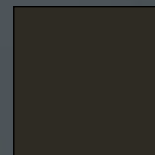

Henné



Rame / Copper



Acciaio / Steel



Ottone Antico  
scuro / Antiqued  
dark brass



# VELA CHAIR

Disegno Pininfarina

Sedia con scocca in resina e legno. Base in legno Noce Canaletto o laccato nero beluga lucido. Disponibile anche in metallo cromo lucido. Rivestimento in pelle, pelle finitura Nabuk o tessuto. Opzionale trapuntatura su interno schienale.

*Chair with shell in resin and wood.  
Wooden base in Canaletto Walnut or shiny lacquered nero beluga colour.  
Available also with base in shiny chromed finish.  
Upholstery in leather, Nabuk-finish-leather or in fabric.  
Optional quilting on the internal back.*

In questa pagina / on this page

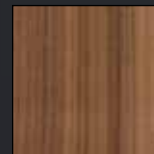

GAMBE/LEGS  
Noce Canaletto/  
Canaletto Walnut

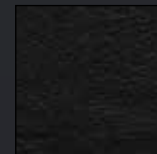

RIVESTIMENTO/  
UPHOLSTERY  
Pelle/Leather  
Nera

Nella pagina precedente / on previous page

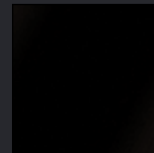

GAMBE/LEGS  
Laccato lucido  
Beluga/Beluga  
shiny lacquered

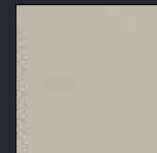

RIVESTIMENTO/  
UPHOLSTERY  
Pelle/Leather  
Ghiaccio

*pininfarina*

STRUTTURA / STRUCTURE



Noce Canaletto /  
Canaletto walnut



Nero Beluga

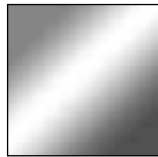

Metallo cromo  
lucido / Shiny  
chrome metal

RIVESTIMENTO / UPHOLSTERY



Pelle / Leather

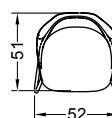
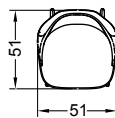
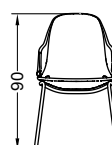
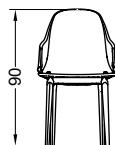
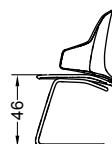

# SIT

Disegno Pininfarina

Sedia con struttura in faggio naturale oppure tinto ciliegio, noce, noce Canaletto, wenge, laccato nero opaco o lucido oppure in Noce Canaletto.

Disponibile senza o con due braccioli, con un bracciolo destro o sinistro.

Schienale in alluminio, cromo lucido, nichel nero lucido o finitura ottone antico scuro.

Rivestimento in tessuto, velluto, pelle, pelle finitura Nabuk.

*Chair with structure in natural beechwood or painted in cherrywood, walnut, Canaletto walnut, wenge, matt or shiny black lacquered finish or in Canaletto Walnut.*

*Available with 2 arms or without, with 1 right or 1 left arm.*

*Back in aluminium, shiny chrome, shiny black nickel finish or in antiqued dark brass finish.*

*Upholstery in fabric, velvet, leather, Nabuk-finish-leather.*

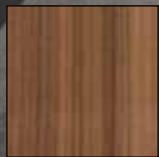

GAMBE / LEGS  
Noce Canaletto/  
Canaletto walnut



SCHIENA / BACK  
Ottone antico  
scuro/Antiqued  
brass



RIVESTIMENTO/  
UPHOLSTERY  
Pelle Naturale/  
Natural leather  
Ghiaccio



## GAMBE / LEGS

Faggio /  
BeechwoodCigliegio /  
Cherrywood

Noce / Walnut

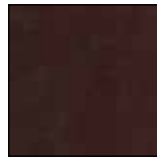
Noce Canaletto /  
Canaletto Walnut

Wenge

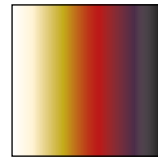
Laccato nero  
Beluga opaco o  
lucido / Matt or  
shiny lacquered  
nero Beluga  
colourLaccato tinta pelle  
/ Matt lacquered  
as leather colourPelle / Leather  
Velluto / Velvet

## RETRO SCHIENALE / BACK

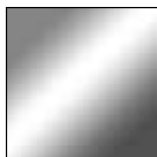
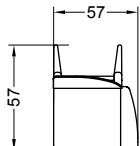
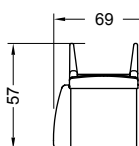
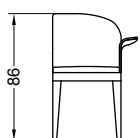
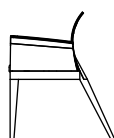
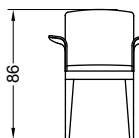
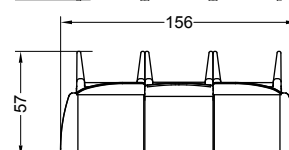
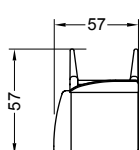
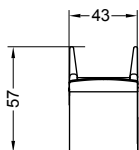
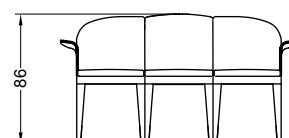
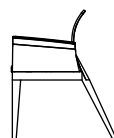
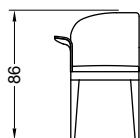
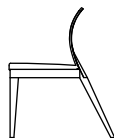
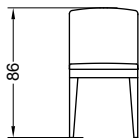
Alluminio /  
AluminiumCromo lucido /  
Shiny chromeNickel nero lucido/  
Shiny black NickelOttone Antico  
scuro / Antiqued  
dark brass





# SEGNO LIBRERIA e MOVIE SPECCHIO TV

Disegno Pininfarina

Libreria modulare con struttura e ripiani curvati in legno, finitura Rovere Henné o laccato opaco. Disponibile illuminazione LED con touch-system. Componibile con MOVIE Specchio TV, dotato di cornice sagomata in legno laccato opaco, disponibile in 2 varianti di misure e per TV fino a 60".

*Modular bookcase with wooden structure and curved shelves in Oakwood Henné or in matt lacquered finish. LED lighting with touch-system. Can be connected to MOVIE TV-mirror with shaped wooden frame in matt lacquered finish, available in 2 different sizes and for TV till 60".*

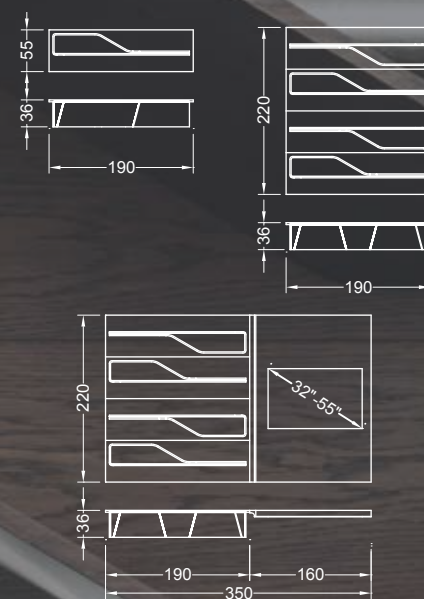

STRUTTURA /  
STRUCTURE  
Rovere /Oakwood  
Henné

# SEGNO BUFFET

Disegno Pininfarina

Credenza con struttura in Rovere Henné oppure in finitura laccato lucido.

Dotata di 1 anta a ribalta e 1 o 2 ante a battente con vano unico e ripiano in cristallo trasparente. Vano a giorno disponibile in tinta con la struttura, in finitura rame o acciaio orbitale oppure rivestito in vetro acidato verniciato con illuminazione a LED opzionale. Gambe in cristallo trasparente o in metallo finitura Titanium.

*Sideboard with wooden structure in Oakwood Henné or in shiny lacquered finish.*

*Equipped with 1 folding door and 1 or 2 doors with internal transparent glass shelf. Open space available in the same colour as the structure, in orbital copper or steel finish or covered with lacquered etched glass. Optional LED lighting.*

*Legs in transparent glass or in Titanium finish metal.*



STRUTTURA /  
STRUCTURE  
laccato Fumo  
lucido / Fumo  
shiny lacquered

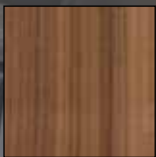

VANO A GIORNO  
/ OPEN SPACE  
Noce Canaletto /  
Canaletto walnut



GAMBE / LEGS  
Titanium



STRUTTURA / STRUCTURE



Laccato lucido /  
shiny lacquered

Rovere /Oakwood  
Henné

VANO A GIORNO / OPEN SPACE



Rame / Copper

Acciaio / Steel

Vetro acidato  
verniciato /  
Etched lacquered  
glass

GEMBE / LEGS

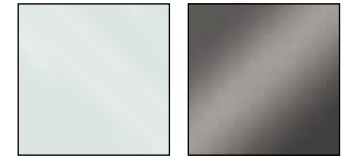

Vetro / Glass

Titanium



# SEGNO CREDENZA LOW

Disegno Pininfarina

Credenza con struttura in Rovere Henné oppure in finitura laccato lucido.

Dotata di 1 anta a ribalta e 1 o 2 ante a battente con vano unico e ripiano in cristallo trasparente.

Vano a giorno disponibile in tinta con la struttura, in finitura rame o acciaio orbitale oppure rivestito in vetro acidato verniciato con illuminazione a LED opzionale. Gambe in cristallo trasparente o in metallo finitura Titanium.

*Sideboard with wooden structure in Oakwood Henné or in shiny lacquered finish.*

*Equipped with 1 folding door and 1 or 2 doors with internal transparent glass shelf. Open space available in the same colour as the structure, in orbital copper or steel finish or covered with lacquered etched glass. Optional LED lighting. Legs in transparent glass or in Titanium finish metal.*

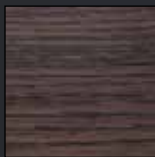
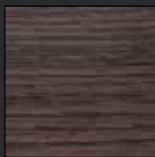
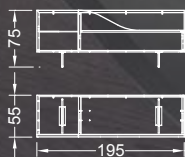

STRUTTURA /  
STRUCTURE  
Rovere /Oak  
wood Henné

VANO A GIORNO  
/ OPEN SPACE  
Rovere /Oak  
wood Henné

GAMBE / LEGS  
Vetro / Glass

STRUTTURA / STRUCTURE



Laccato lucido /  
shiny lacquered

Rovere Hennè /  
Oak Hennè

VANO A GIORNO / OPEN SPACE



Rame / Copper

Acciaio / Steel

Vetro acidato  
verniciato /  
Etched lacquered  
glass

GEMBE / LEGS



Vetro / Glass

Titanium



In questa pagina SEGNO CREDENZA LOW Rovere Hennè con vano a giorno in vetro a specchio.  
On this page SEGNO CREDENZA LOW Oakwood Hennè finish with open space in mirror glass.



## REFLEX STYLE COORDINATION

### *index*

63	BULLES XL COLLEZIONE
67	LUCCIOLA PIANTANA
69	LUX COLLEZIONE
71	ZENITH POLTRONA LOW
73	JAZZ POLTRONA
75	SEVENTY TAVOLINI
78	AENIGMA 40
80	VELA 40
82	KENDO 55
84	LUCE SPECCHIO
85	IMPACT SPECCHIO
86	SEVENTY SPECCHI
87	PRISMA SPECCHIO TV





AGIORNORIEGA



AENIGMA 40



PG. 78

LUCCIOLA  
COLLECTION



PG. 67

MOVIE SPECCHIO TV



PG. 49





IMPACT SPECCHIO



PG. 85

VELA 40



PG. 80

SEVENTY SPECCHIO



PG. 86

ZENITH POLTRONA LOW  
JAZZ POLTRONA



PG. 71

KENDO 55



PG. 82





BULLES COLLECTION



PG. 63

LUX COLLECTION



PG. 69

SEVENTY 40



PG. 75

LUCE SPECCHI



PG. 84

PRISMA SPECCHIO TV



PG. 87



1. Bulles XL Applique con supporto specchio fumé incisioni London / *Bulles XL Applique with support in smoke mirror with London engravings*  
2. Bulles XL Abatjour Move / *Bulles XL Abatjour Move*  
3. Bulles XL Piantana e Nuvola Poltrona / *Bulles XL Piantana and Nuvola Poltrona*

## BULLES XL COLLEZIONE

Disegno Reflex

Collezione caratterizzata da sfere in vetro borosilicato in 3 diverse dimensioni con finitura filtro luce in bronzo, argento, oro e rame con lampadine interne a LED.

Lampadario con supporto tondo o rettangolare in vetro verniciato bianco, nero o a specchio con 5 sfere pendenti oppure in versione singola.

Piantana con inclinazione regolabile, con struttura in acciaio satinato e dettagli in ottone antico scuro, dotata di 3 sfere.

Abatjour fisso o orientabile con 1 sfera e supporto in acciaio satinato.

Plafoniera con 1 sfera e supporto in acciaio satinato.

Applique con 2 sfere e supporto rettangolare in vetro specchio fumé o con incisioni London.

*Collection of lamps characterized by spheres in 3 different sizes in borosilicate glass with 'light filter' finish in bronze, silver, gold and copper with internal LED bulbs.*

*Chandelier with round or rectangular glass support in white, black or mirror finish with 5 pendant spheres or with single pendant sphere.*

*Floor lamp with adjustable inclination in glazed steel with details in antiqued dark brass, equipped with 3 spheres in*

*Table lamp in fix or adjustable version with 1 sphere and support in glazed steel.*

*Ceiling lamp with 1 sphere and glazed-steel support.*

*Wall lamp with 2 spheres and rectangular support in smoke mirror glass or with London.*



**reflex**

*pininfarina*

HOME DESIGN



BASE ABATJOUR E PIANTANA  
TABLE AND FLOOR LAMP BASE

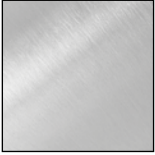

Acciaio satinato /  
Glazed steel

SUPPORTO LAMPADARI / CHANDELIER SUPPORT



Bianco / White



Nero / Black

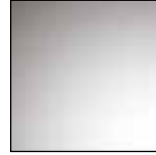

Specchio / Mirror

SFERE / SPHERES



Rame / Copper



Oro / Gold



Argento / Silver



Bronzo / Bronze

Abatjour / Table lamp

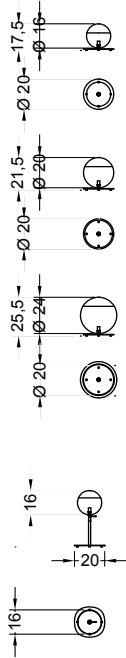

Piantana / Floor lamp

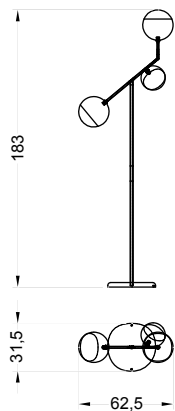

Lampadario / Chandelier

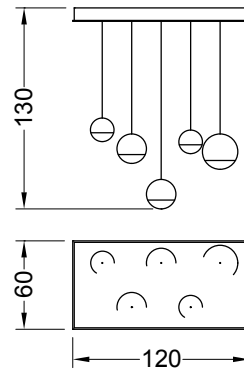
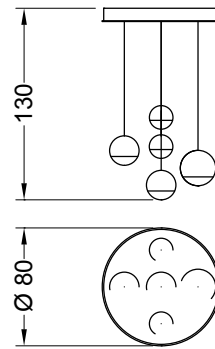
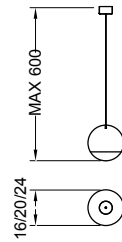

Applique / Wall lamp

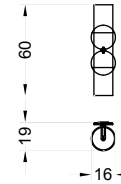

Plafoniera / Ceiling lamp

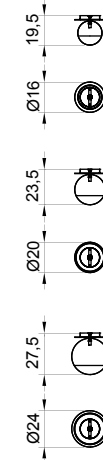

**reflex**  
*pininfarina*  
HOME DESIGN



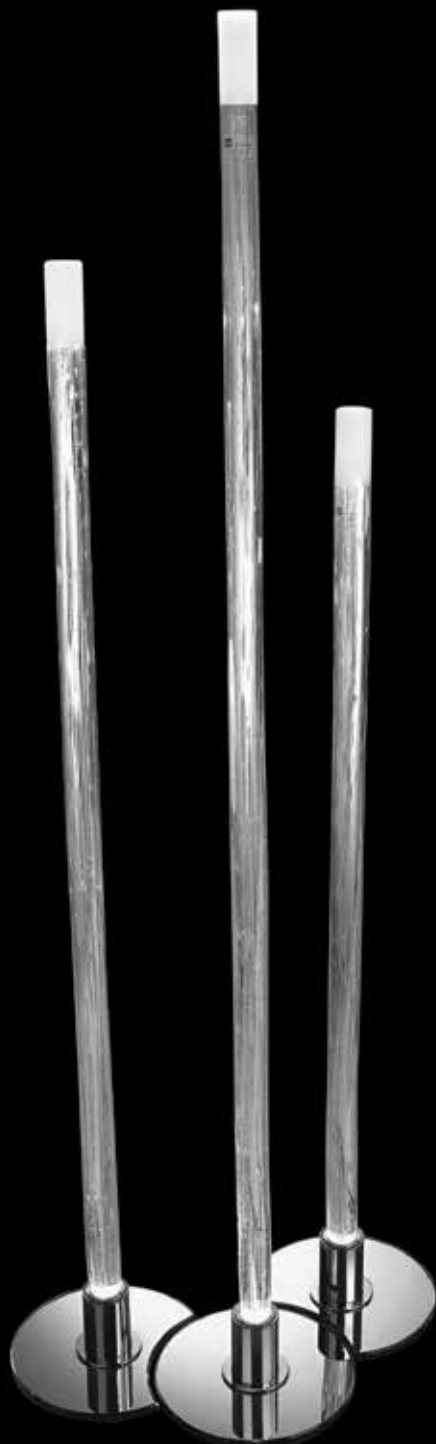

# LUCCIOLA PIANTANA

Disegno Reflex

Piantana in vetro di Murano lavorato a mano, sabbiato all'estremità superiore. Base in vetro specchio in versione tonda o a mezzaluna. Impianto luce a LED.

La collezione si completa con l'Applique e con il tavolino laterale.

*Floor lamp in handmade Murano glass, sandblasted on the top. Base in mirror glass available in round or in half-moon shape for the floor. LED lighting system.*

*The collection is completed by the wall lamp and the side table.*

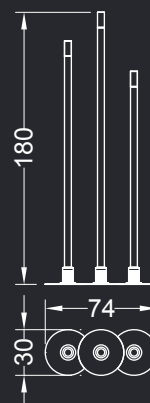
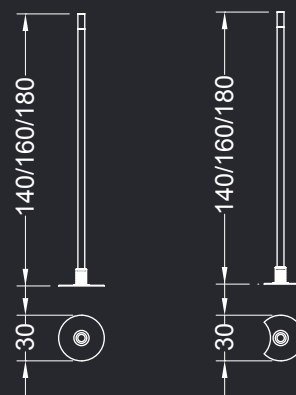

VETRO PIANTANA / GLASS FLOOR LAMP

Trasparente /  
Transparent

Acidato / Etched

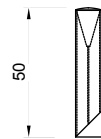
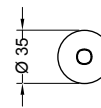
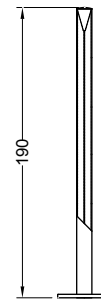

## LUX COLLEZIONE

Disegno Tulkzinsky

Collezione di piantane e applique in vetro borosilicato con supporti in alluminio cromato con illuminazione a LED. Piantana disponibile in versione trasparente oppure sfumato con doppia illuminazione e regolatore di luce.

*Collection of floor and wall lamps in borosilicate glass with chromed aluminium supports with LED lighting system. Floor lamp available in transparent or in shaded glass with double light and dimmer.*





In questa pagina ZENITH poltrona low con base in ottone antico scuro e rivestimento tessuto Luxury Regent Street 07. Pagina successiva versione con base acciaio inox satinato e rivestimento Pelle finitura Nabuk Caffé 08.  
*On this page ZENITH poltrona low with base in antiqued dark brass and upholstery in fabric Luxury Regent Street 07. On next page with base in glazed stainless steel and upholstery in Nabuk finish leather Caffé 08.*

# ZENITH POLTRONA LOW

Disegno Marco Cocco

Poltrona con struttura in poliuretano. Basamento tondo girevole in acciaio inox satinato o in finitura ottone antico scuro.  
Rivestimento in pelle o in pelle finitura Nabuk.

*Armchair with shell in polyurethane. Swivelling round base in glazed stainless steel or in antiqued dark brass.  
Upholstery available in leather or Nabuk-finish-leather.*

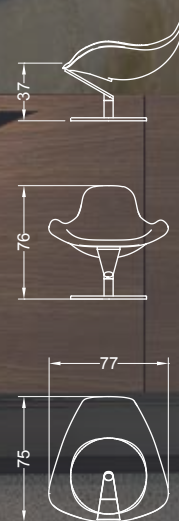

BASE  
Laccato ottone  
antico / Antiqued  
brass lacquered



RIVESTIMENTO/  
UPHOLSTERY  
Luxury - Regent  
Street dark  
magenta





In questa pagina JAZZ Poltroncina con rivestimento tessuto Extra Brera 09. Pagina successiva rivestimento tessuto Extra Brera 05.  
On this page JAZZ Poltroncina upholstered in fabric Extra Brera 09. On next page upholstery in fabric Extra Brera 05.

# JAZZ POLTRONCINA

Disegno Reflex

Poltroncina con struttura tubolare in metallo.  
Rivestimento in tessuto, velluto, pelle o in pelle  
finitura Nabuk.

*Low chair with tubular metal frame.  
Upholstery available in fabric, velvet, leather or  
Nabuk-finish-leather.*

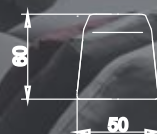

RIVESTIMENTO/  
UPHOLSTERY  
Super - Brera  
Antique Ruby



Nell'immagine tavolino misure 48x45x52h con piano in vetro Mesh e tavolino misure 139x73x37h con piano Bevel Wood con vetro acidato verniciato Henné. Basamenti in finitura Titanium.  
*On photo side table size 48x45x52h with top in Mesh glass and low table size 139x73x37h with top in Bevel Wood with etched lacquered glass Henné colour. Base in Titanium finish.*

## SEVENTY 40

Disegno Reflex

Collezione di tavolini sagomati con base in metallo finitura Grafite o Titanium. Piano in cristallo spessore 10mm filo lucido verniciato o acidato verniciato, in vetro Carbonio o in vetro Mesh. Piano disponibile anche in legno spessore 25mm con bordo rastremato 45°(Bevel Wood) in Noce Canaletto, Rovere Henné, Ebano opaco o lucido, finitura rame o ottone antico scuro, oppure laccato opaco rivestito in vetro verniciato o acidato verniciato.

*Collection of shaped low and side tables with metal base in Grafite or Titanium finish. Top in 10mm thick lacquered or etched lacquered glass, Carbon glass or Mesh glass. Available also with top in 25mm thick wood with tapered edges 45°(Bevel Wood) in Canaletto walnut, Oakwood Henné, matt or shiny Ebony wood, copper or in antiqued dark brass finishing or matt lacquered covered with lacquered or etched lacquered glass.*



TOP SEVENTY 40



Nero Beluga      Latte      Fumo      Carbonio      Mesh

TOP SEVENTY 40 BEVEL WOOD



Noce Canaletto / Canaletto Walnut      Rovere / Oakwood Hennè      Ebano opaco o lucido / Matt or shiny ebony wood      Rame / Copper      Ottone antico scuro / Antiqued dark brass      Nero Beluga      Fumo      Creta

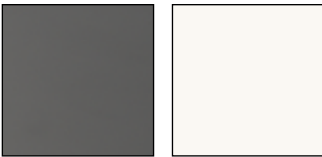

Hennè      Latte

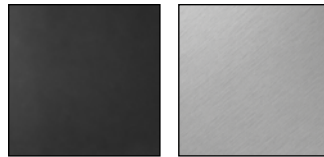

Grafite      Titanium

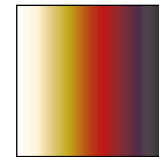

Vetro verniciato lucido o acidato / Laquered or etched glass

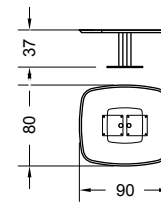
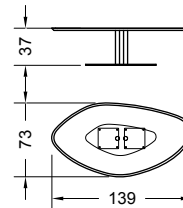
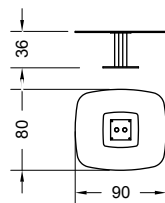
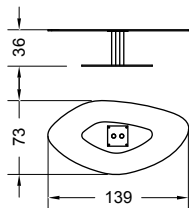
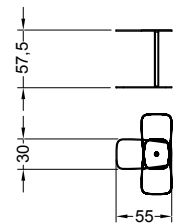
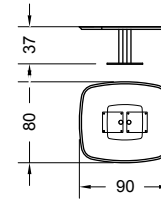
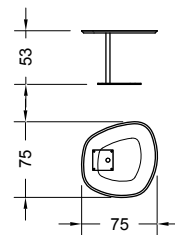
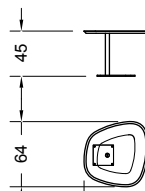
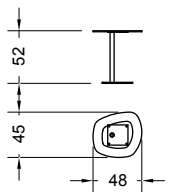

# AENIGMA 40

Disegno Reflex

Tavolino con base composta da elementi sagomati  
Disponibile in finitura Wengé o rame lucido.  
Piano in cristallo trasparente 12 mm.

*Coffee table with base composed by shaped  
elements available in Wengé or in shiny copper  
finishing.*

*Top in 12mm thick transparent glass.*



TOP SEVENTY 40



Wengè



Rame / Copper

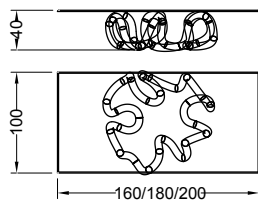
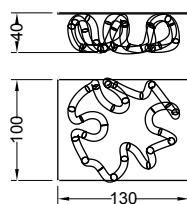
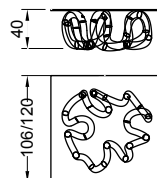
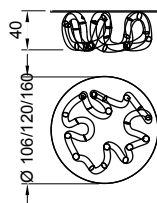



## VELA 40

Disegno Reflex

Tavolino con base in cristallo curvato trasparente, disponibile anche in vetro extrachiaro o bronzo o fumé acidato, vetro extrachiaro verniciato o acidato verniciato nei colori di serie. Piano in cristallo spessore 12mm.

*Coffee table with transparent curved glass base, available also in extraclear or bronze or smoked etched glass, extraclear lacquered or etched lacquered glass, standard colours. Glass top 12mm thick.*



BASE



Extra acidato /  
Extraclear etched  
glass

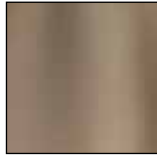

Bronzo acidato  
/ Etched Bronze  
glass



Fumè acidato /  
Etched Smoke  
glass



Nero Beluga  
lucido

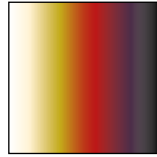

Vetro verniciato o  
acidato verniciato  
/ Lacquered or  
etched lacquered  
glass

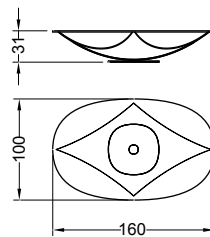
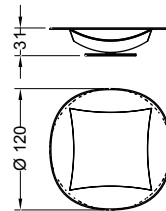
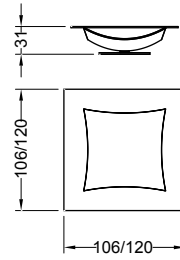

# KENDO 55

Disegno Tulczinsky

Tavolino laterale con supporto in vetro di Murano disponibile nelle versioni: base cristallo blu e supporto blu/verde; base cristallo fumé supporto grigio sfumato; base cristallo bianco e supporto bianco acidato sfumato. Piano centrale in cristallo sp10 con bisello 45°.

*Side table in Murano glass, available in: blue base and blue/green tube; smoked glass base and grey tube; white base and white frosted tube. Glass top 10 mm th. with 45° bevel.*



## BASE

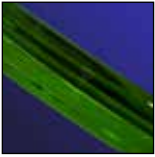

base blu,  
supporto blu-  
verde  
blue base, blue /  
green tube



base fumé,  
supporto grigio  
sfumato /  
smoked glass  
base, grey tube



base bianca,  
supporto acidato  
sfumato /  
white base, white  
frosted tube

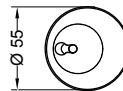
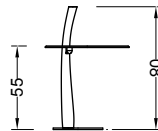

# LUCE SPECCHIO

Disegno Reflex

Collezione di specchi spessore 5mm con bisello a 45° con serigrafie e illuminazione interna.  
Posizionabili orizzontalmente o verticalmente.

Collection of mirrors 5mm thick with 45° bevel with serigraphy designs and back lighting.  
Can be placed both in horizontal or vertical position.

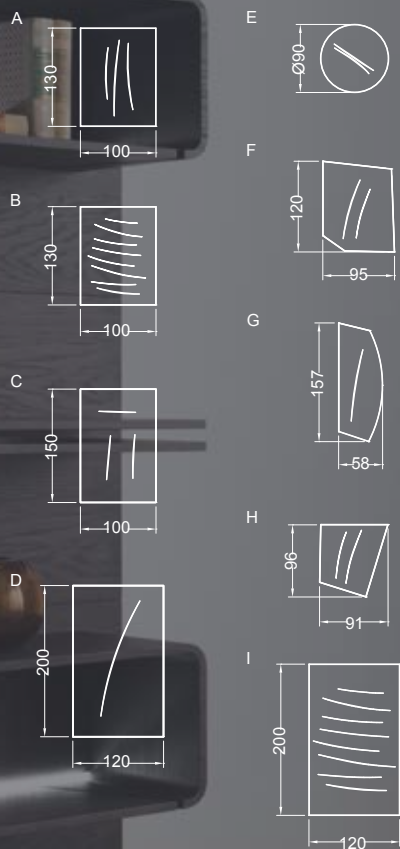

# IMPACT SPECCHIO

Disegno Reflex

Specchio extrachiaro sp.5mm disponibile in tondo, rettangolare o ovale con cornice in acciaio Supermirror.

*Extra clear mirror 5mm thick available in round, rectangular or oval shape with frame in Supermirror steel.*

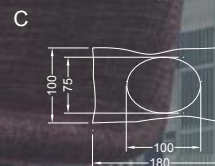
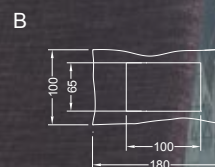

# SEVENTY SPECCHI

Disegno Reflex

Collezione di specchi in vetro extrachiaro sp.8mm con forme e bisello irregolare.

Collection of mirror in extra clear glass 8mm th. with irregular shape and bevel.

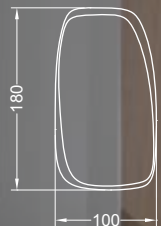
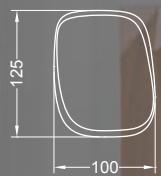
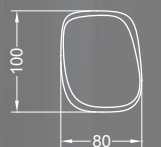
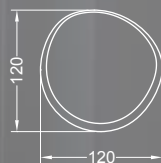
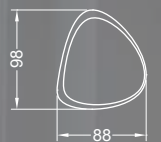

# PRISMA SPECCHIO TV

Disegno Reflex

Specchio/contenitore TV in vetro Supersilver. Può contenere TV LED di spessore massimo 7cm da 32" a 70".

Cornice disponibile in specchio fumé, vetro verniciato o acidato verniciato, vetro Carbonio o vetro Mesh. Illuminazione LED tra specchio e cornice opzionale.

*Tv container/mirror in Supersilver glass. Can fit LED televisions with a 7cm maximum thickness from 32" to 70". Frame available in smoked mirror, lacquered or etched lacquered glass, Carbon glass or Mesh glass. Optional LED lighting between mirror and frame.*

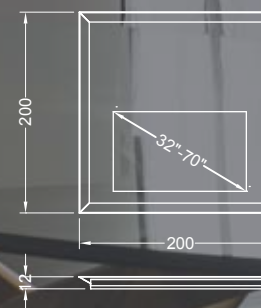
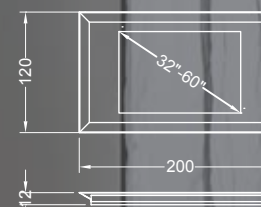
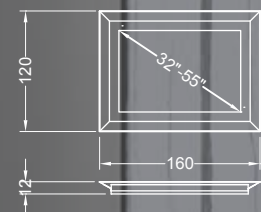





**MATERIALS**  
*index*

TESSUTO  
PELLE CAT. C  
PELLE COLORATA  
PELLE NATURALE  
PELLE CAT. C FINITURA NABUK  
VELLUTO OPACO  
VELLUTO GLAMOUR

## TESSUTO / FABRIC

### Super - Via Condotti

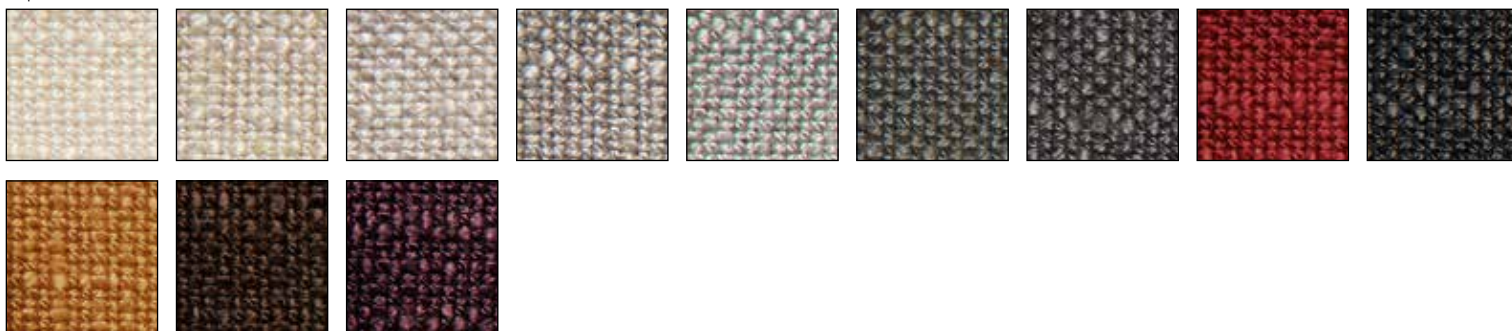

### Extra - Brera



### Extra - Montenapoleone

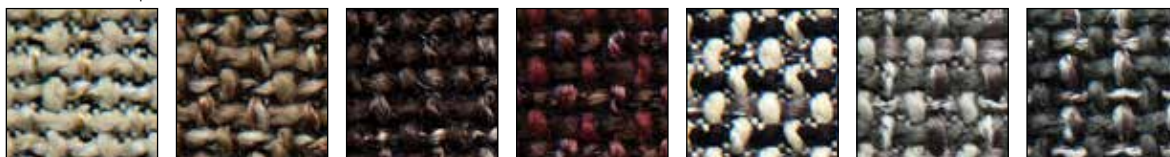

### Extra - Via Spiga



### Luxury - Regent Street

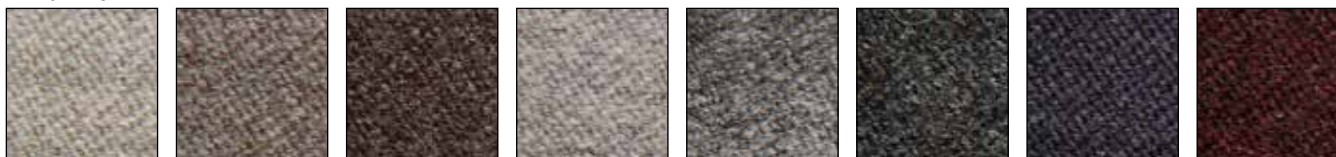

### Luxury - Bond's Street



# CAMPIONARIO PELLE / LEATHER COLLECTION

## PELLE CAT. C / CAT. C LEATHER



## PELLE COLORATA / COLOURED LEATHER



## PELLE NATURALE / NATURALE LEATHER



## PELLE CAT. C FINITURA NABUK / LEATHER IN NABUK FINISH

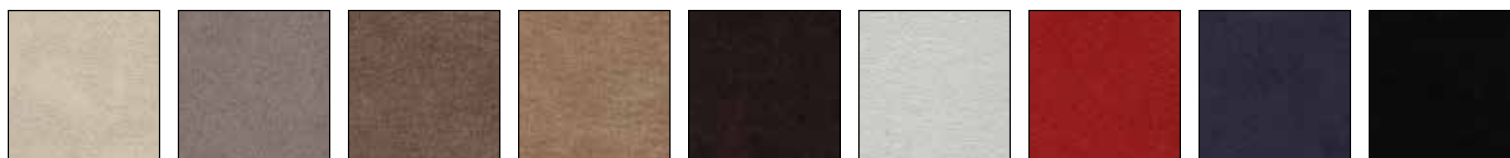

# CAMPIONARIO VELLUTI / VELVET COLLECTION

## VELLUTI / VELVET

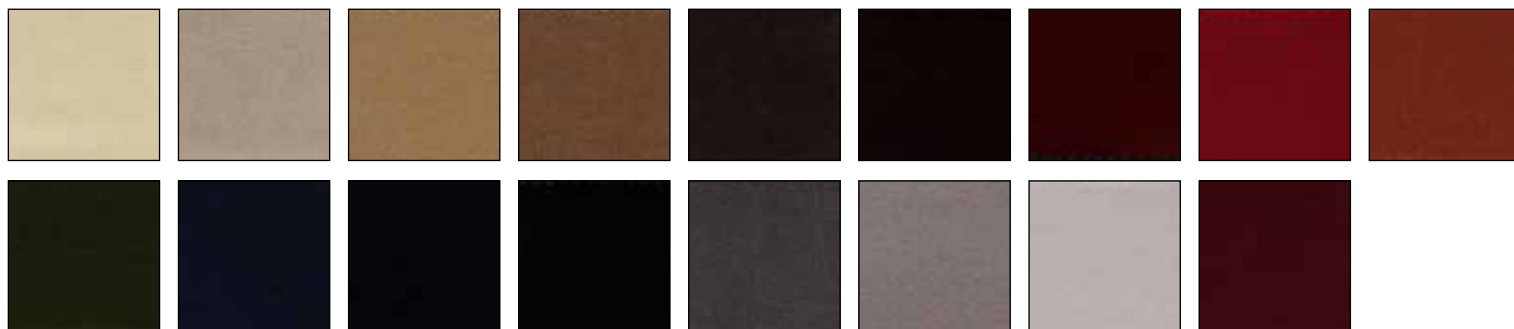

## VELLUTI / VELVET GLAMOUR



**reflex**

reflexangelo.com