

Collier
SADLER®



ITALAMP

The only limit is one's imagination

ITALAMP

Collier SADLER

L'unico limite è l'immaginazione
The only limit is one's imagination

COLOR FEELINGS 5

COLLIER ELEMENTS 15

BESPOKE PROJECTS 27

SOLUTIONS 41

INDEX



Francese nato in Austria, Marc Sadler vive attualmente a Milano. Uno dei primi laureati in "esthétique industrielle" all'ENSAD di Parigi con una tesi sulle materie plastiche, è stato pioniere della sperimentazione dei materiali e della contaminazione fra le tecnologie, divenute aspetti distintivi della sua attività. Cittadino del mondo (ha vissuto e lavorato per molti anni in Europa, Nord America e Asia) e progettista eclettico, è oggi consulente di aziende nei più svariati settori dell'industria.

All'inizio degli anni '70 mette a punto il primo scarpone da sci in materiale termoplastico interamente riciclabile, poi industrializzato dall'italiana Caber (della famiglia Caberlotto che fonderà in seguito Lotto), della quale conquista rapidamente la responsabilità di tutte le linee di prodotto instaurando una lunga e fruttuosa

collaborazione segnata dal brevetto dello scarpone con scafo simmetrico, rimasto per parecchi anni il più venduto al mondo. È questa l'origine della sua specializzazione nel design dello sport che lo porta a lavorare con le più importanti multinazionali in USA, Asia, Giappone ed Europa, sia nelle scarpe sportive che in molti altri settori dello sport: sci, racchette da tennis, mazze da golf, etc. La provenienza da un ramo dell'industria dove la ricerca e sperimentazione di nuovi materiali e processi produttivi è diffusa, gli consente di esportare conoscenze in settori dove è radicato il concetto di design circoscritto alla forma estetica.

4 volte vincitore del Compasso d'Oro ADI (Associazione Design Industriale), oltre a 2 Menzioni d'Onore e 2 Selezioni speciali, ha ricevuto molti altri importanti riconoscimenti internazionali nel corso dei anni. Il paraschiama disegnato per Dainese è nella collezione permanente di design del MOMA di New York e la Mite di Foscarini fa parte della collezione design del Beaubourg di Parigi.

A dispetto della pur meritata reputazione di designer tecnico Marc Sadler è appassionato di pittura e disegno, emotivamente coinvolto al punto di considerarli i suoi interessi più autentici.

French citizen born in Austria, Marc Sadler currently lives in Milan.

One of the first graduates in "esthétique industrielle" at the ENSAD in Paris with a thesis on plastics, he was a pioneer in experimentation on the different materials and contamination between technologies, which has become distinctive aspects of his work. A man of the world (he has lived and worked for many years in Europe, North America and Asia) and eclectic designer, today he is a consultant for companies in many industry branches such as lighting, furnishing, large and small household appliances, sport and of other technical sectors.

In the early seventies, he perfect the first ski-boot in thermoplastic material completely recyclable, subsequently commercialized by the Italian firm Caber (owned by the Caberlotto family which later will establish Lotto). He quickly gains the responsibility of the entire collections and starts a long and fruitful collaboration which led to the patenting of the ski-boot with a symmetric shell, which was for many years the most widely-sold ski-boot in the world. This is the beginning of his specialization as a sports designer, which led to close collaboration with the most important multinational sport companies in the United States, Asia, and Europe, in either sport shoes and other sport fields: ski, tennis rackets, golf clubs, etc. Working in this sector, which has often pioneered research into new materials and techniques, provided the experience to enable him to bring innovation to more traditional areas where is set a concept of design as pure aesthetic shape.

Awarded 4 times with the Compasso d'Oro ADI (Industrial Design Association) as well as 2 Honorable Mention and 2 special Selection, his work has won many international design awards over the years. The motorcyclist's back protector designed for Dainese is now housed in the permanent collection of design at the MOMA in New York and the lamp Mite (Foscarini) is part of the design collection of the Beaubourg in Paris.

Despite his reputation as a technical designer, Marc Sadler is passionate for painting and drawing, finding it so emotionally absorbing as to consider it his real passion.

ITALAMP

Collier SADLER



Il vetro è un materiale meraviglioso. Perché è un materiale vivo, in continuo movimento. Una materia trasformista, proprio come Collier, il nuovo sistema di illuminazione disegnato da Marc Sadler per Italamp.

Il nome Collier rimanda ad una collezione virtuale di bijoux di una signora elegante. In una dimensione estetica degli oggetti che può esprimersi dal più rigoroso minimalismo fino all'iper decorativo, si immaginano o collane, orecchini pendenti, spille, in una chiave di lettura ludica e simboleggiante, che racconta la ricchezza del sistema. Collier si contorce, seduce, è una struttura mossa da infinite declinazioni di luce e colori, dalle forme assolutamente originali. Pensato in diverse composizioni, Collier può stare in ambienti residenziali così come in spazi commerciali e hotel. Un prodotto con una fascinazione complessa, che attira ed incanta: dalla combinazione di singoli elementi verticali o orizzontali, fino alla versione da tavolo, da terra, da parete, Collier trova facilmente la propria collocazione e crea scenari ricchi di charme.

Unico limite? La fantasia.

Glass is a wonderful material, because it is a living material in continuous movement. It is changeable, just like Collier, the new lighting system designed by Marc Sadler for Italamp.

The name Collier refers to a virtual collection of jewellery for an elegant lady. Aesthetically, the objects can range from strictly minimal to hyper-decorative, bringing to mind necklaces, pendent earrings or broaches in a playful, symbolic way that expresses the system's richness. Collier contorts and seduces in a structure enlivened by infinite variations of light and colours, with completely original forms. Conceived in a variety of compositions. Collier is suitable for residential settings, as well as commercial and hotel environments. A product with a complex allure that attracts and enchants, it is available in combinations that include single vertical or horizontal elements, as well as table, floor and wall light versions. Collier easily finds its place and creates charming settings.

The only limit is one's imagination.

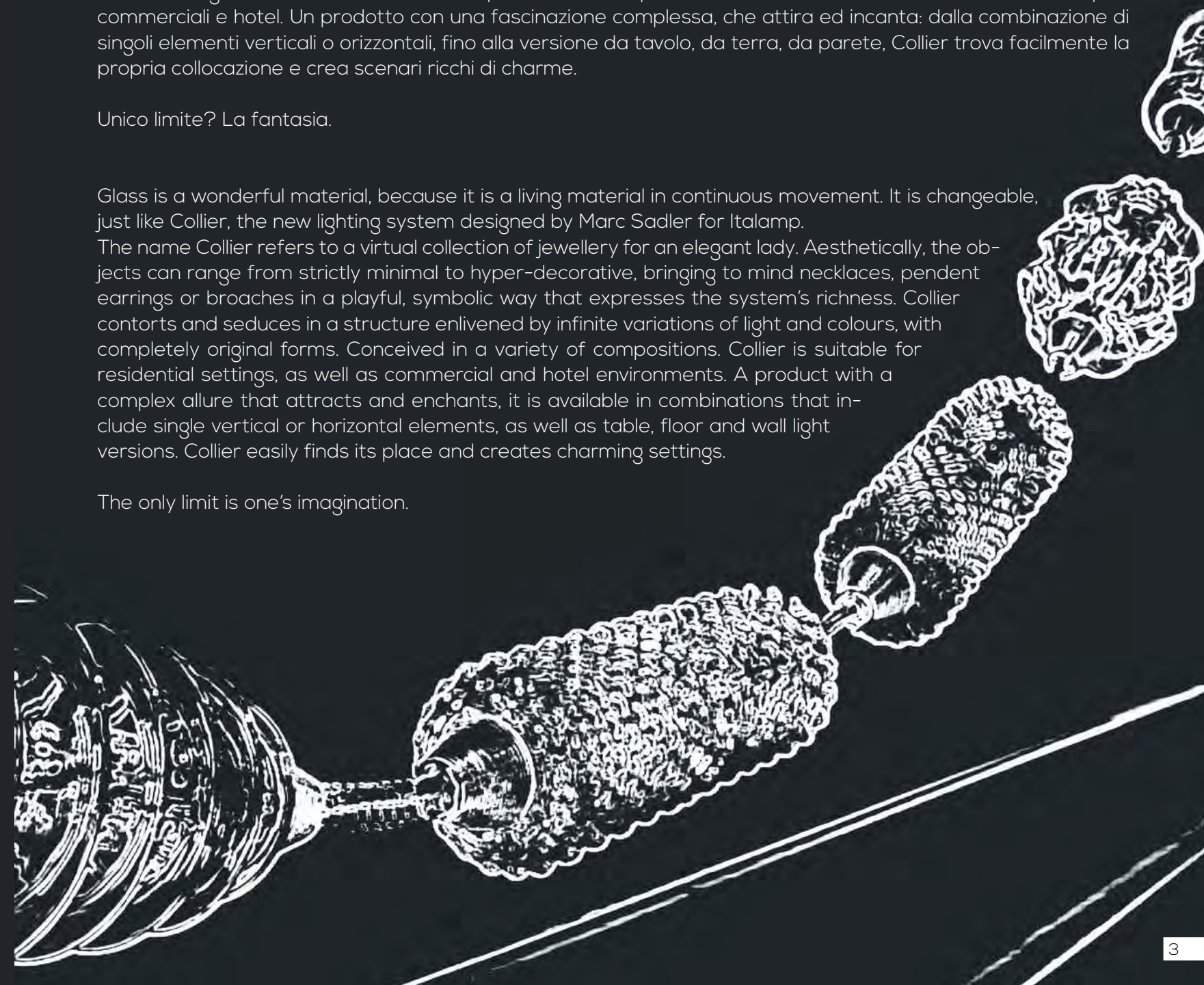



COLOR FEELINGS

COLOR FEELINGS

LA SCELTA DEL COLORE

I colori sono un elemento determinante nell'arredamento e nella decorazione della nostra casa e creano un'atmosfera diversa a seconda delle sfumature che accostiamo negli arredi e nelle pareti.

Arredare con i colori giusti è un punto fondamentale per realizzare una ambientazione perfetta.

Ma quando devi scegliere i colori per la casa, non basta considerare solo la luminosità e la dimensione degli ambienti, perché vanno valutati anche gli abbinamenti fra i colori delle pareti, dell'arredamento, dei tessuti e dell'illuminazione, in modo da creare un'atmosfera coerente, che non strida.

THE CHOICE OF COLOR

Colours are a decisive element in the furniture and in the decoration of our house. They create a different atmosphere according to the shades that we put near in furnishings and walls. Furnishing with the right colours is a fundamental point to achieve the perfect setting. But when you have to choose the colours for the house it is not enough to consider only the brightness and the dimension of the spaces, you also have to examine the combination between the colours of the walls, the furniture, the ,textiles and of the lightning, in order to create a coherent and an harmonious atmosphere.



NEUTRAL



WARM



COLD





COLOR FEELINGS

TONALITA' NEUTRE

Le tonalità neutre sono rappresentate da bianco, nero, grigi e tutti quelle sfumature neutre come il tortora o l'avorio. Perfetti per i locali come la camera da letto o la zona tv e soprattutto tutti i locali deputati al relax. I toni neutri, utilizzati per le pareti o gli arredi della camera da letto, sono in grado di conferire all'ambiente notte un tocco di eleganza rendendo la stanza intima e confortevole.

Eleganti e discreti, sono versatili per le molte sfumature fredde e calde. Sobri e, per il loro effetto calmante, si abbinano bene ad arredamenti moderni e minimalisti. Capaci di accompagnarsi ad altri toni e colori, contrastano bene col giallo e il verde.

NEUTRAL TONES

Neutral colours are represented by white, black, greys and all those neutral shades like dove or ivory. These are perfect for the bedroom, the TV area and for all the spaces dedicated to a relaxing moment. Neutral colours, which are used for the walls and for the furnishings of the bedroom, can convey an elegant touch to the sleeping area and give an intimate and cosy feeling. Elegant and discreet, neutral shades are versatile for the many cold and warm tones. They are also sober colours and, because of their calming effect, they perfectly match modern and minimalist furnishings. Neutral tones harmonize with other shades and colours and contrast well with green and yellow.





WARM

COLOR FEELINGS

TONALITA' CALDE

I toni caldi sono in grado di far scattare una serie di effetti emotivi, hanno un'azione stimolante in grado di accelerare l'attività cardiaca e quella respiratoria.

Sono ideali per favorire una reazione attiva e vitale. Stimolano l'allegria, l'attività mentale e la concentrazione. E sono i colori ideali da utilizzare in ambienti esposti a sud.

WARM TONES

Warm tones can stir several emotional effects. They have a stimulating outcome able to accelerate the heart and respiratory activities. They are also perfect to achieve an active and vital reaction. Warm tones stimulate cheerfulness, mental activity and concentration. Furthermore, they are ideal colours to use in facing south rooms.





COLD

COLOR FEELINGS

TONALITA' FREDDI

Le tonalità di colore fredde sono ideali per creare ambienti rilassanti, dove potersi distendere e dove riposare lontano dallo stress. Sono indicati per gli ambienti esposti alla luce nel pomeriggio e sono ideali per creare ambienti intimi. Perfetti per i locali come la camera da letto o la zona tv, possono essere utilizzati insieme a palette di colori neutri per creare ambienti eleganti e accoglienti.

COLD TONES

Cold tones are perfect to create relaxing environments where to lie down and to rest away from stress. They are suitable for rooms that are exposed to the afternoon light and are also perfect to produce an intimate setting. Cold tones are ideal for bedrooms and TV areas and can be used together with neutral palettes to create cosy and warm spaces.





ELEMENTS

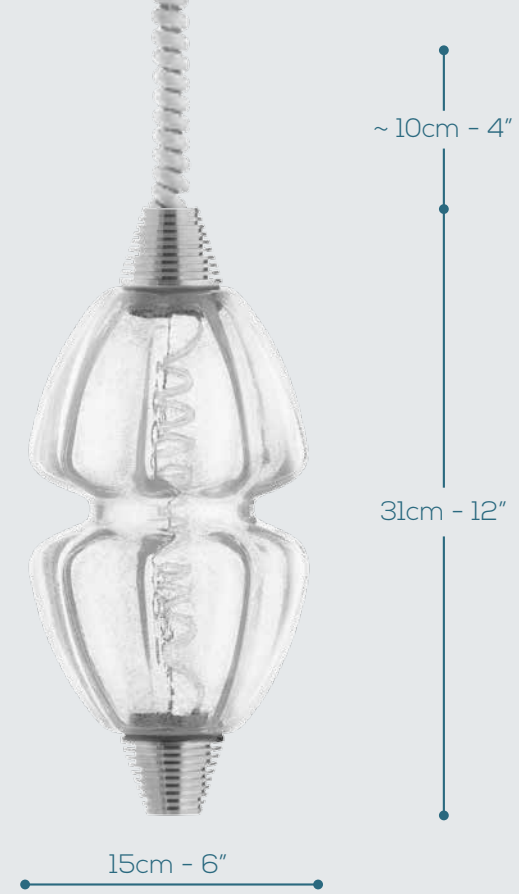
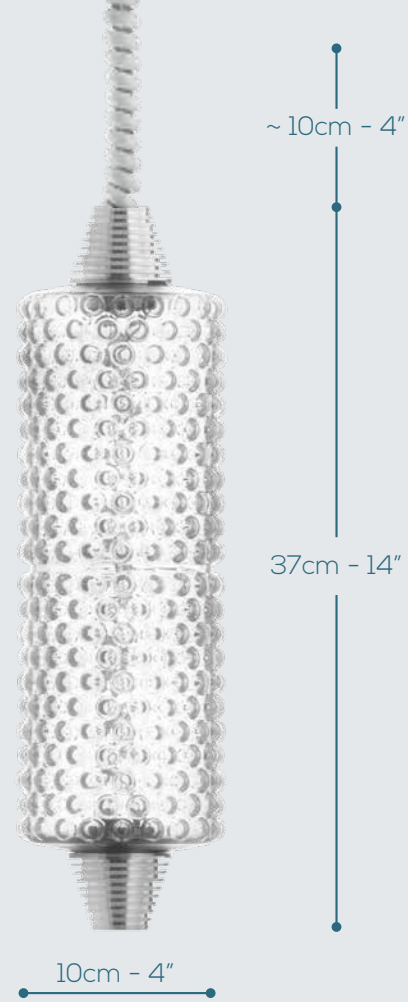
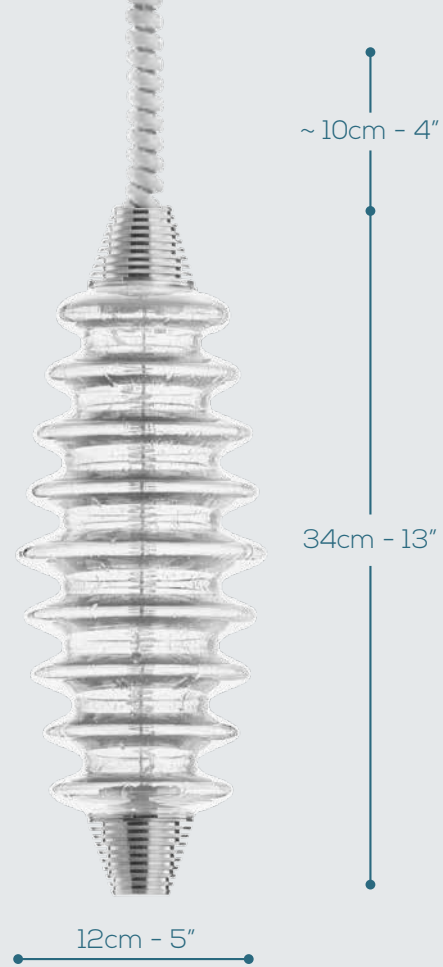

ELEMENTO 1 | ITEM 1

MATERIALI
MATERIALS
 CORPO: Alluminio
 BODY: Aluminium
 VETRO: Pulegoso
 GLASS: Pulegoso

LAMPADINE
BULBS
 2x3w Led - 3000K - 700Lumen

DIMENSIONI
DIMENSIONS
 ALTEZZA - HEIGHT: 34 cm 13"
 DIAM.: 12 cm 5"

PESO - WEIGHT
 Approx. 0.8kg 1.8 lbs

A richiesta
 On request



ELEMENTO 2 | ITEM 2

MATERIALI
MATERIALS
 CORPO: Alluminio
 BODY: Aluminium
 VETRO: Trasparente
 GLASS: Clear

LAMPADINE
BULBS
 2x3w Led - 3000K - 700Lumen

DIMENSIONI
DIMENSIONS
 ALTEZZA - HEIGHT: 37 cm 14"
 DIAM.: 10 cm 4"

PESO - WEIGHT
 Approx. 0.85kg 1.9 lbs

A richiesta
 On request



ELEMENTO 3 | ITEM 3

MATERIALI
MATERIALS
 CORPO: Alluminio
 BODY: Aluminium
 VETRO: Anticato
 GLASS: Antique

LAMPADINE
BULBS
 2x3w Led - 3000K - 700Lumen

DIMENSIONI
DIMENSIONS
 ALTEZZA - HEIGHT: 31 cm 15"
 DIAM.: 15 cm 6"

PESO - WEIGHT
 Approx. 0.75kg 1.6 lbs

A richiesta
 On request

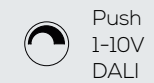
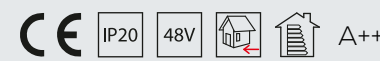

ELEMENTO 4 | ITEM 4

MATERIALI
MATERIALS
 CORPO: Alluminio
 BODY: Aluminium
 VETRO: Anticato
 GLASS: Antique

LAMPADINE
BULBS
 2x3w Led - 3000K - 700Lumen

DIMENSIONI
DIMENSIONS
 ALTEZZA - HEIGHT: 34 cm 13"
 DIAM.: 14 cm 6"

PESO - WEIGHT
 Approx. 0.9kg 2 lbs

A richiesta
 On request

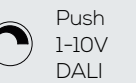

COLORS

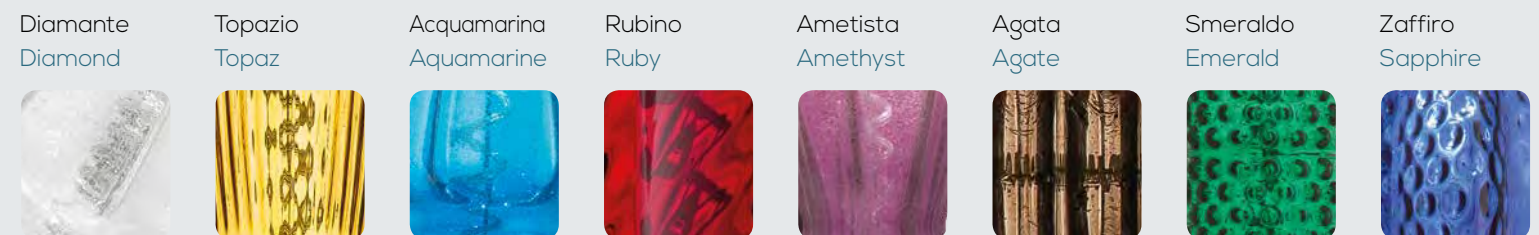

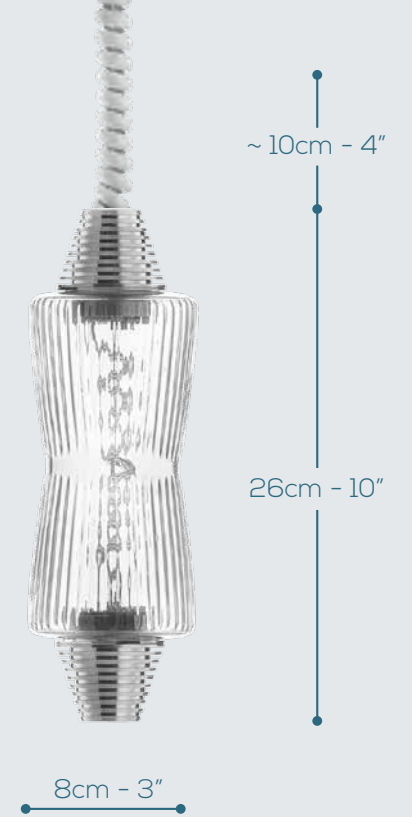
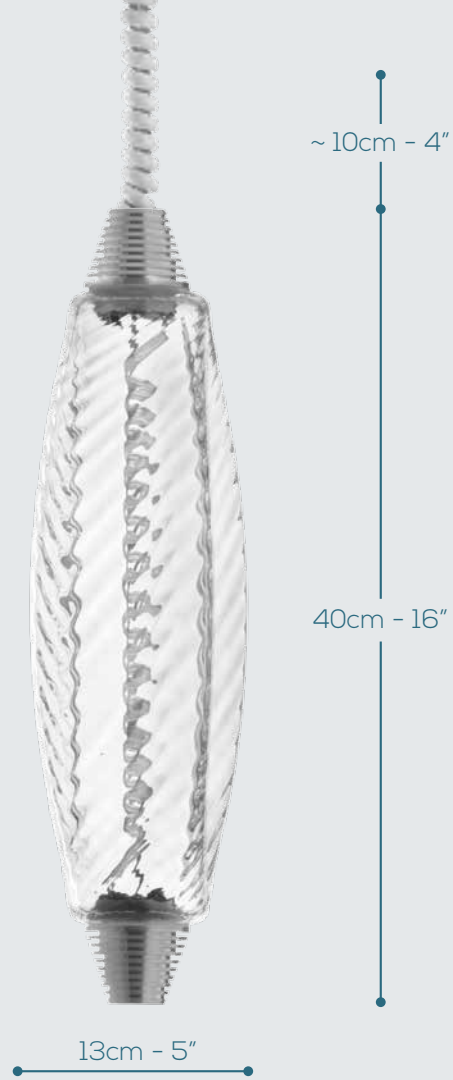
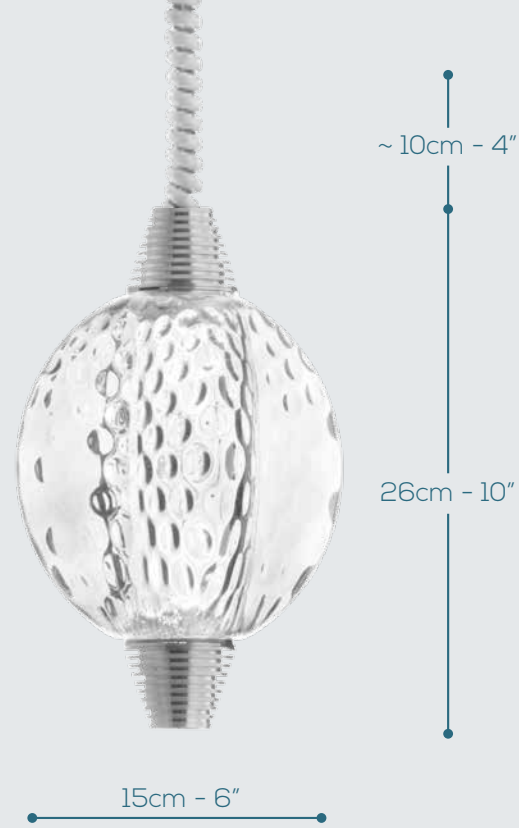

ELEMENTO 5 | ITEM 5

MATERIALI
MATERIALS
CORPO: Alluminio
BODY: Aluminium
VETRO: Ballotondo
SHADE: Bubble

LAMPADINE
BULBS
2x3w Led - 3000K - 700Lumen

DIMENSIONI
DIMENSIONS
ALTEZZA - HEIGHT: 26 cm 10"
DIAM.: 15 cm 6"

PESO - WEIGHT
Approx. 0.68kg 1,5 lbs

A richiesta
On request



ELEMENTO 6 | ITEM 6

MATERIALI
MATERIALS
CORPO: Alluminio
BODY: Aluminium
VETRO: Rigato
GLASS: Ruled

LAMPADINE
BULBS
2x3w Led - 3000K - 700Lumen

DIMENSIONI
DIMENSIONS
ALTEZZA - HEIGHT: 40 cm 16"
DIAM.: 13 cm 5"

PESO - WEIGHT
Approx. 0.75kg 1,6 lbs

A richiesta
On request



ELEMENTO 7 | ITEM 7

MATERIALI
MATERIALS
CORPO: Alluminio
BODY: Aluminium
VETRO: Rigato
GLASS: Ruled

LAMPADINE
BULBS
2x3w Led - 3000K - 700Lumen

DIMENSIONI
DIMENSIONS
ALTEZZA - HEIGHT: 29 cm 11"
DIAM.: 8 cm 3"

PESO - WEIGHT
Approx. 0.4kg 0,9 lbs

A richiesta
On request

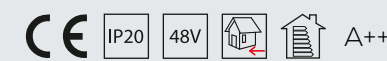

ELEMENTO 8 | ITEM 8

MATERIALI
MATERIALS
CORPO: Alluminio
BODY: Aluminium
VETRO: Rigato
GLASS: Ruled

LAMPADINE
BULBS
2x3w Led - 3000K - 700Lumen

DIMENSIONI
DIMENSIONS
ALTEZZA - HEIGHT: 26 cm 10"
DIAM.: 8 cm 3"

PESO - WEIGHT
Approx. 0.4kg 0,9 lbs

A richiesta
On request

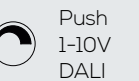

COLORS

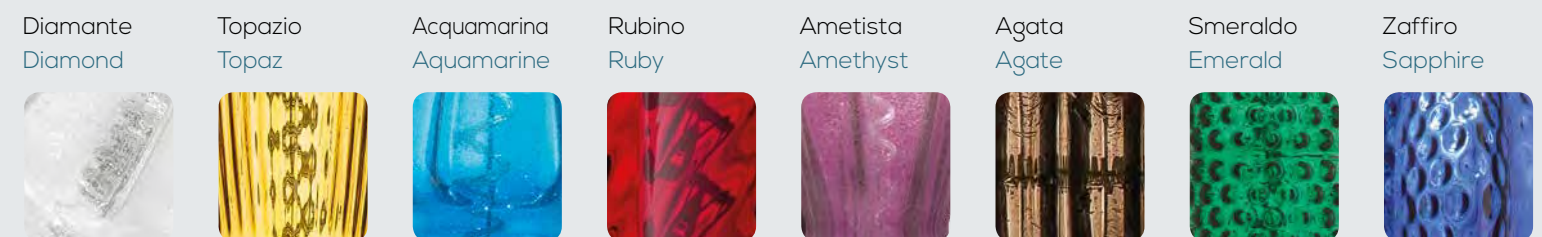

Cosa puoi fare | **What you can do**

Mischiare elementi | **Mix elements**

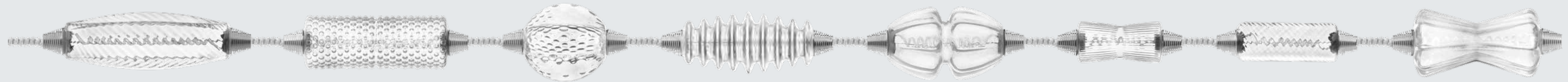

Mischiare colori | **Mix colors**



n°8 max di elementi | **n°8 max of elements**
per driver standard | **for each standard driver**



Dove posizionarlo | Where to place it

Soffitti portanti
Heavy weight resistant ceiling

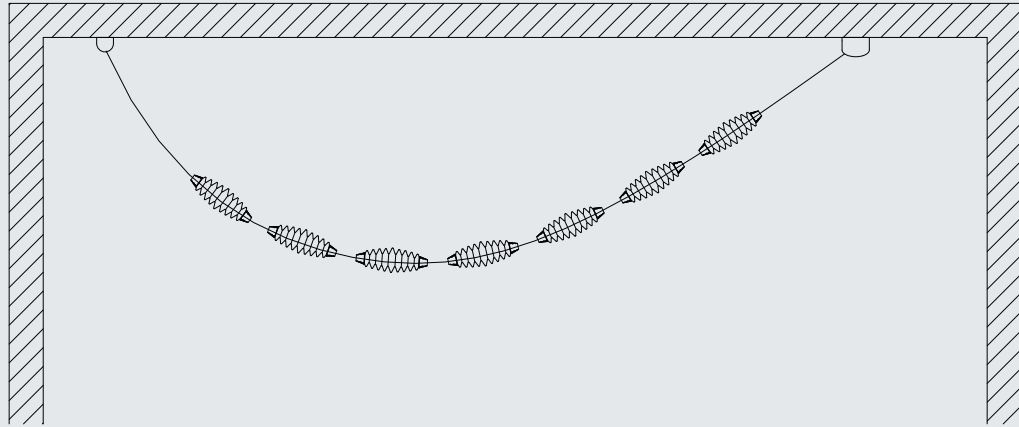

Soffitti portanti
Heavy weight resistant ceiling



Soffitti portanti
Heavy weight resistant ceiling

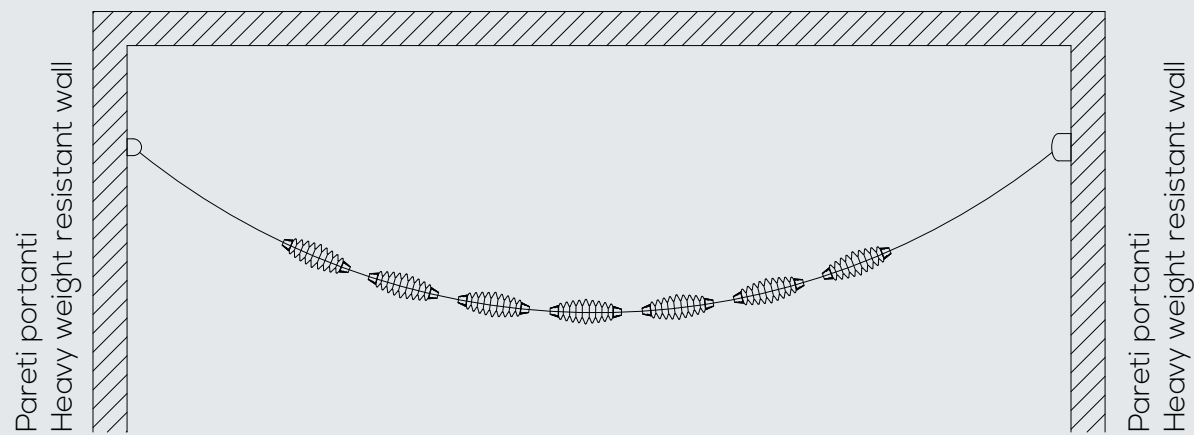
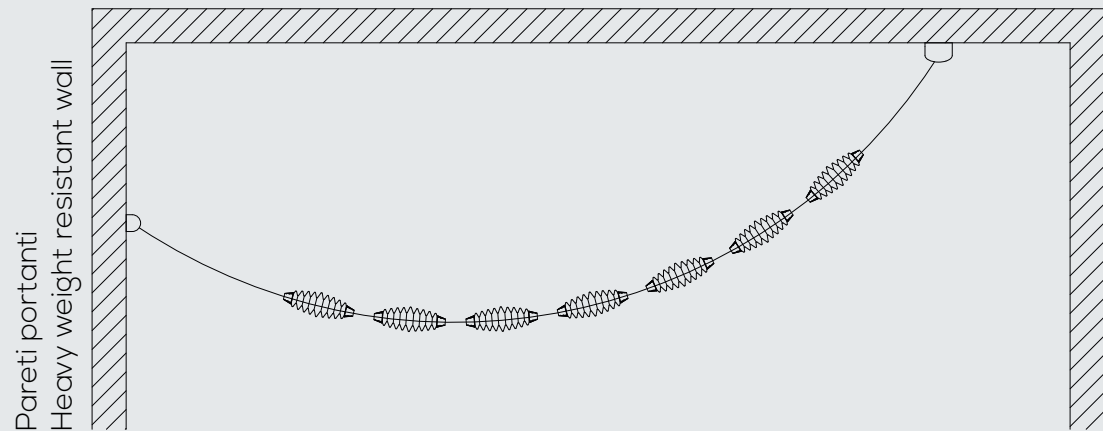

Controsoffitto | False ceiling

Warning !!

Qualsiasi tipo di controsoffitto
Any kind of false ceiling

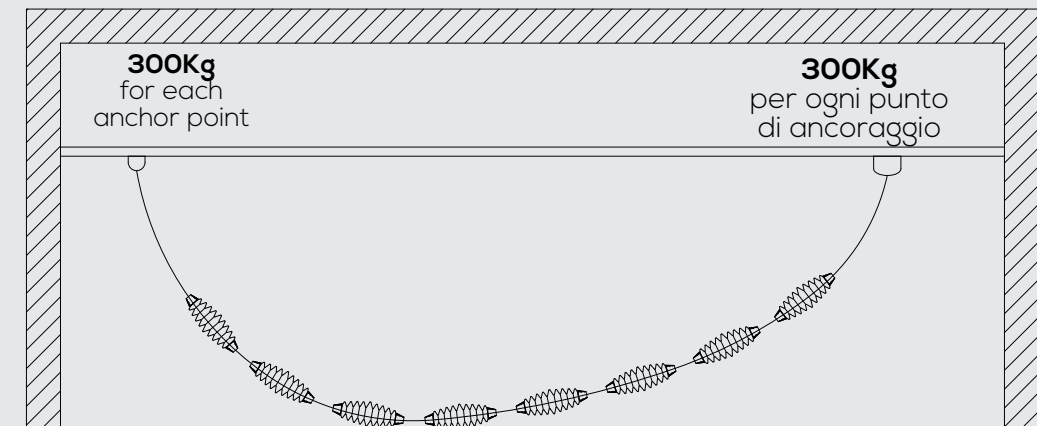

Collier SADLER

Dimensioni e forma dei rosconi cambiano in funzione della composizione e del numero di elementi presenti nella sospensione.

Italamp provvederà a studiare la soluzione tecnico-estetica più adatta alla richiesta del cliente fornendo di volta in volta le specifiche tecniche relative a tutti i dettagli per l'ancoraggio del prodotto.

The dimensions and the shape of the canopies change depending on the compositions and on the number of the elements in the suspension.

Italamp will think of the best technical and aesthetic solution for the client, giving each time the technical specifications concerning all the details for the anchorage of the product.

Posizione driver led | Led driver position

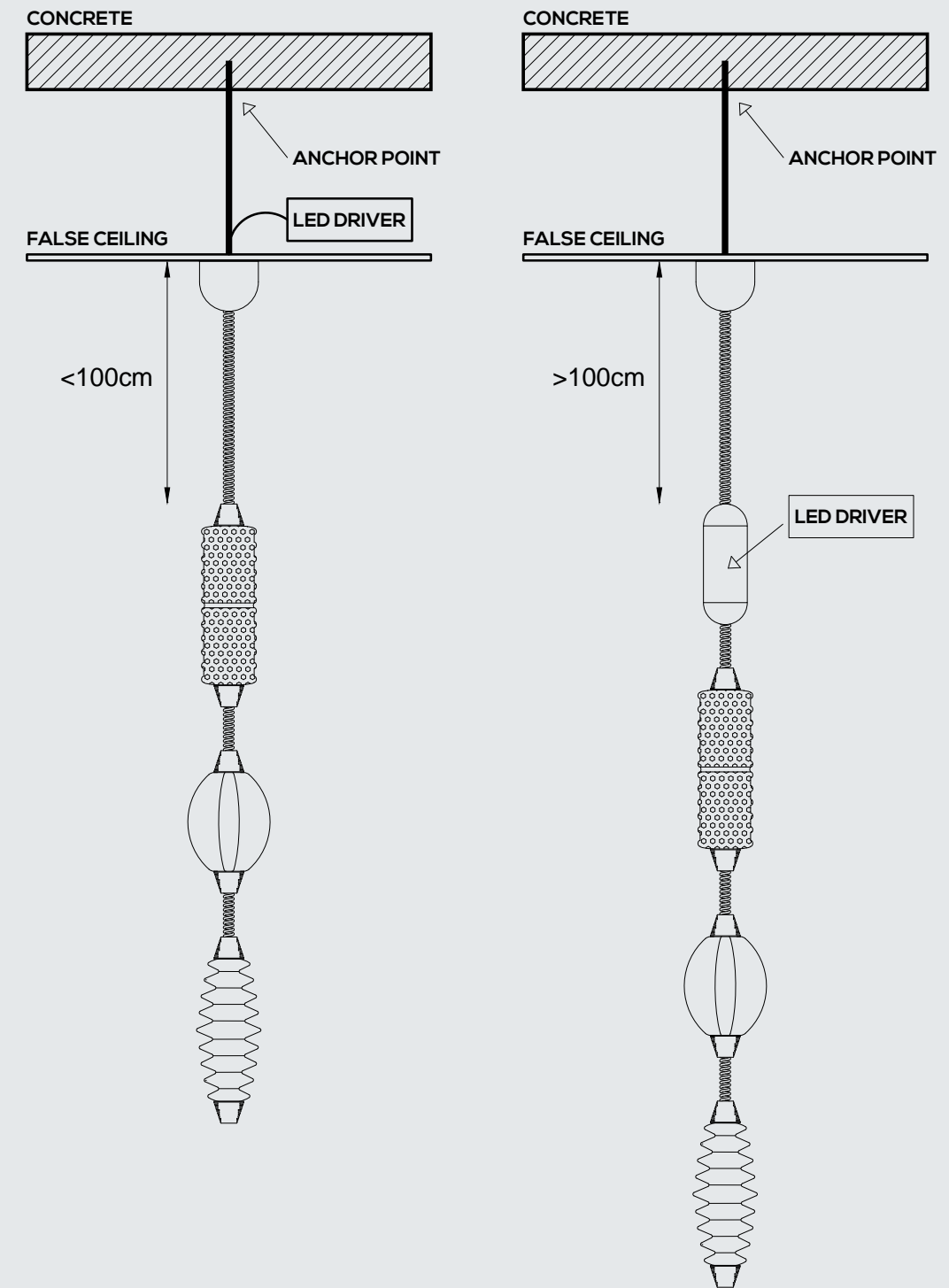
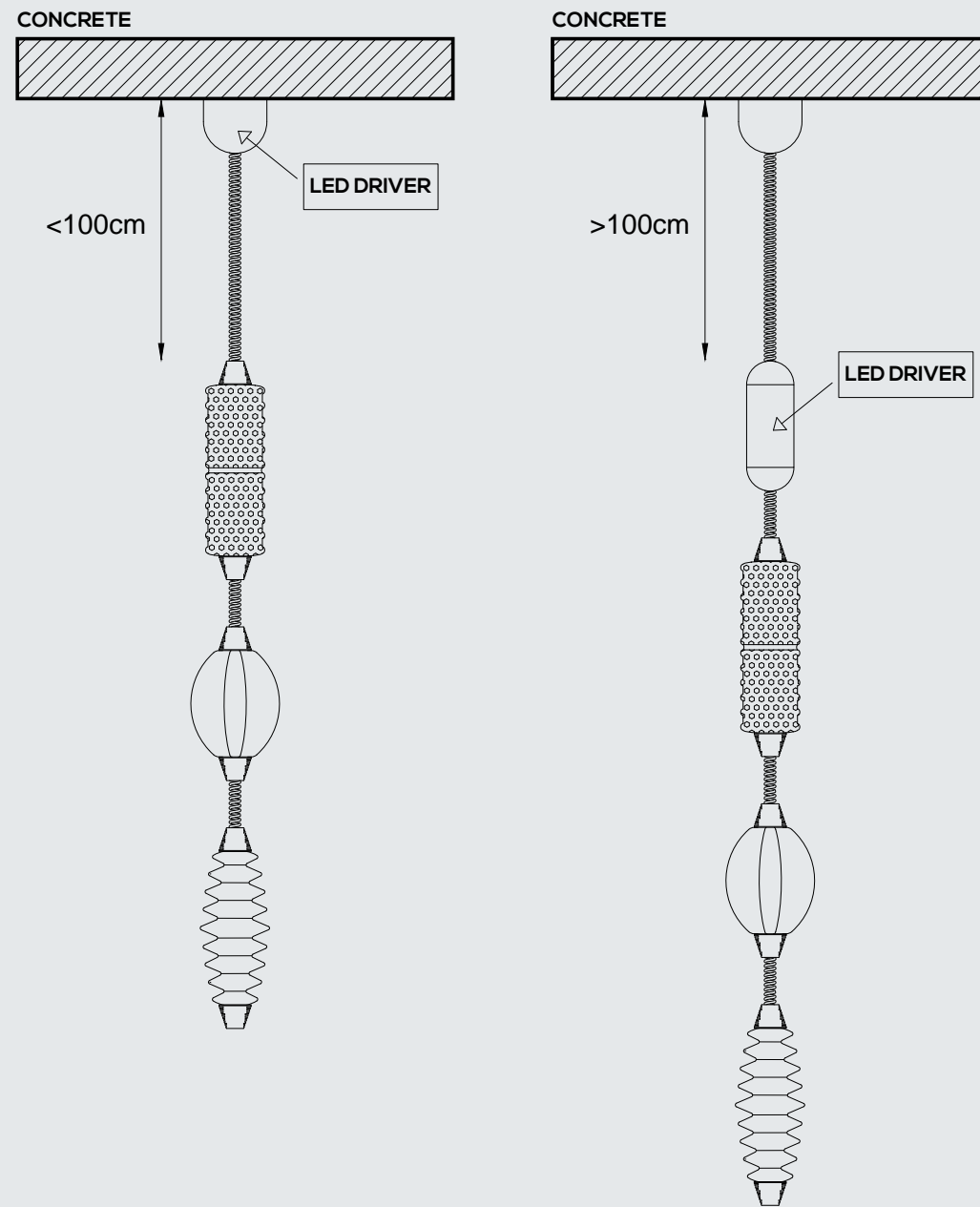

BESPOKE PROJECTS

La divisione Contract di Itlamp si avvale di un team qualificato, a cui è affidata la progettazione di corpi illuminanti negli ambienti del hospitality, del retail, della nautica e delle residenze private ed in grado di seguire step by step con creatività e capacità progettuale ogni esigenza del committente sia dal punto di vista progettuale che economico.

Itlamp's Contract division avails itself of a qualified team to which is entrusted the design of illuminating devices in hospitality and retail environments, in boating spaces and private residences. Furthermore, it is able to follow step by step all the buyer's needs with creativity and planning ability from both an organizing and economic point of view.







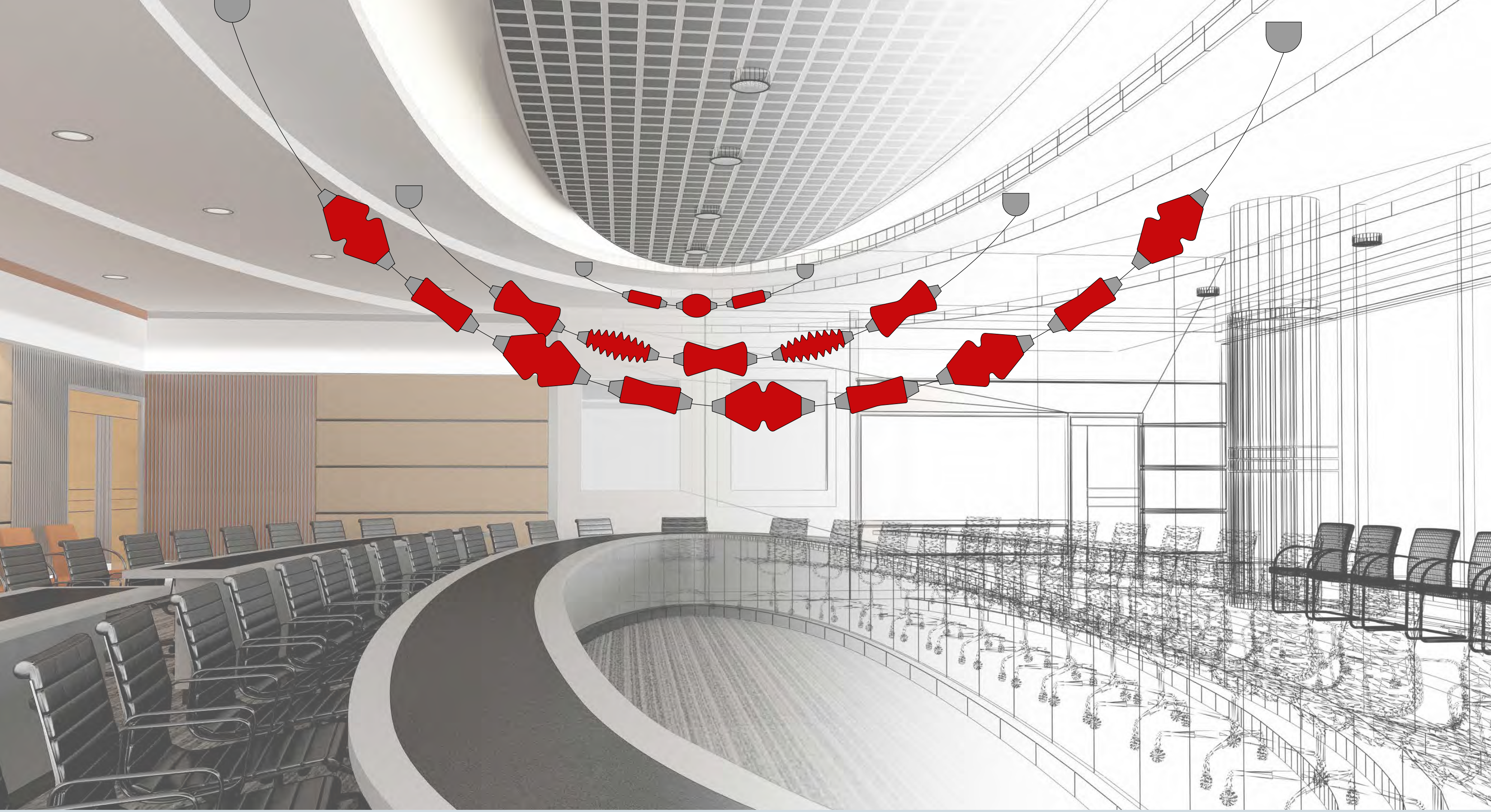

Collier
SADLER

BESPOKE PROJECTS

L'analisi e lo sviluppo dettagliato di tutti gli aspetti del prodotto finito sono sempre al passo con le richieste di sicurezza e funzionalità, unitamente alla garanzia dei valori estetici, qualitativi e tecnici.

The analysis and the detailed development of all the aspects of the finished product always keep abreast of the requests of security and functionality together with the guarantee of the aesthetic, qualitative and technical values.





BESPOKE PROJECTS

Dalla personalizzazione alle soluzioni più articolate richieste dal settore contract, offriamo assistenza dal disegno iniziale fino alla consegna ed eventuale installazione.

From customization to the most various solutions requested by the contract sector, we offer assistance from the initial design to the delivery and a possible installation.

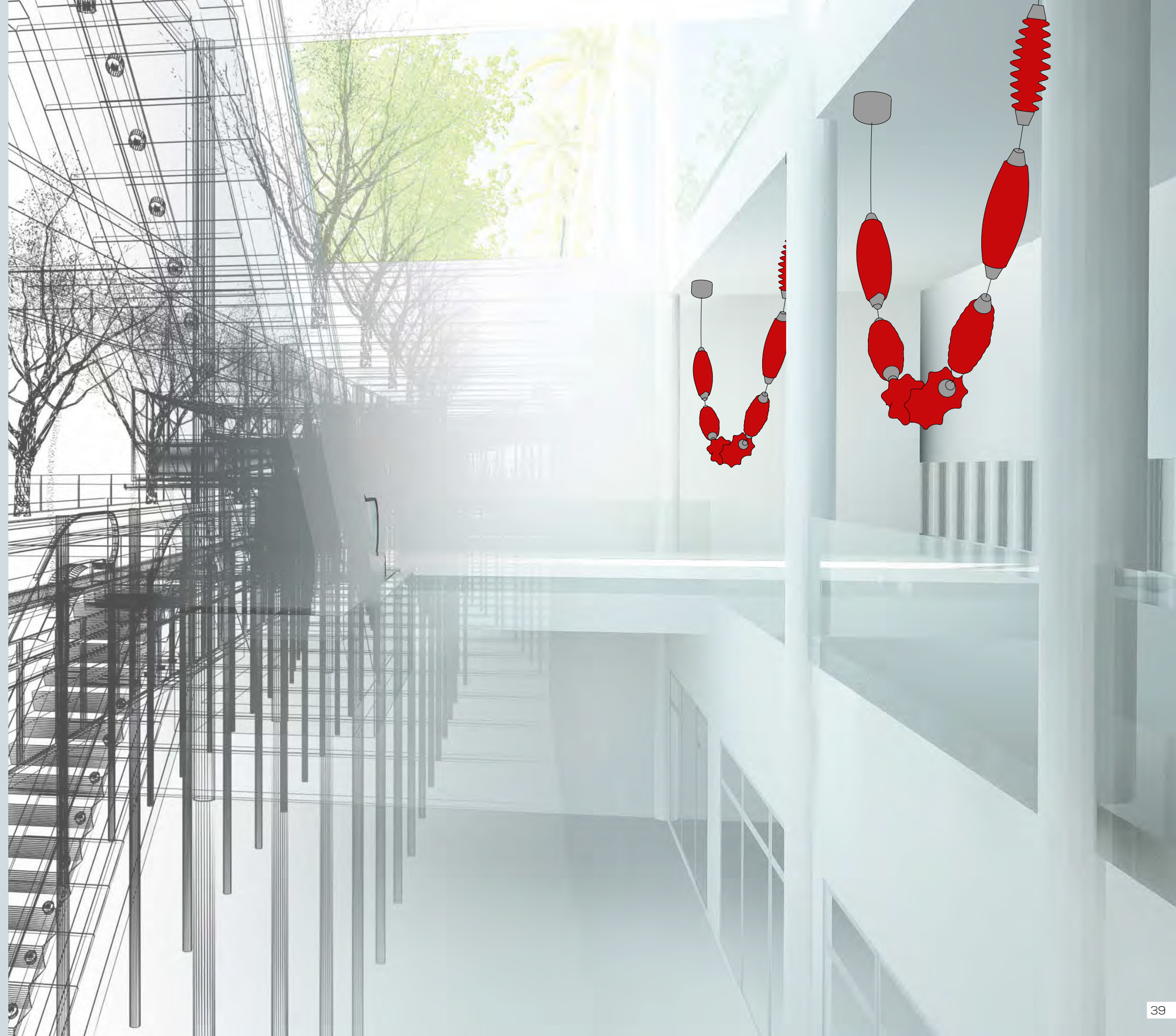

Collier

SADLER

SOLUTIONS

COLLIER T1800/A/B/C/D/E

DESIGNER
MARC SADLER

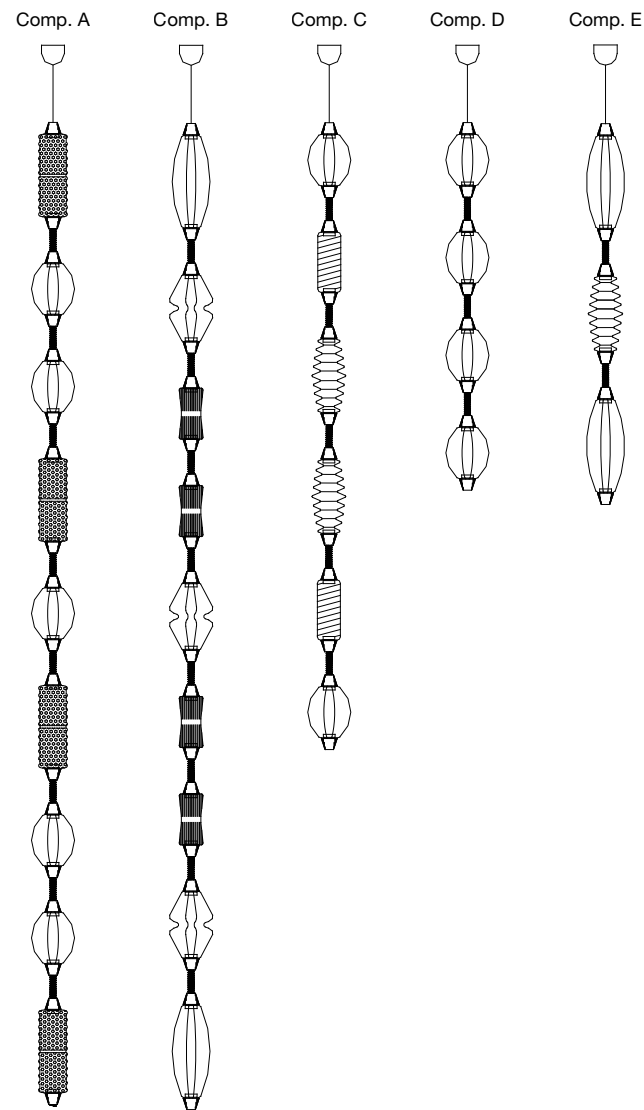

Comp. A
dimensioni _ dimensions
ø15 h.342 _ ø 6" *h.135"
lampadine _ bulbs
54W LED - 6300 Lumen

Comp. B
dimensioni _ dimensions
ø15 h.340 _ ø 6" h.134"
lampadine _ bulbs
54W LED - 6300 Lumen

Comp. C
dimensioni _ dimensions
ø15 h.220 _ ø 6" h.87"
lampadine _ bulbs
36W LED - 4200 Lumen

Comp. D
dimensioni _ dimensions
ø15 h.128 _ ø 6" h.50"
lampadine _ bulbs
24W LED - 2800 Lumen

Comp. E
dimensioni _ dimensions
ø14 h.130 _ ø 6" h.51"
lampadine _ bulbs
18W LED - 2100 Lumen

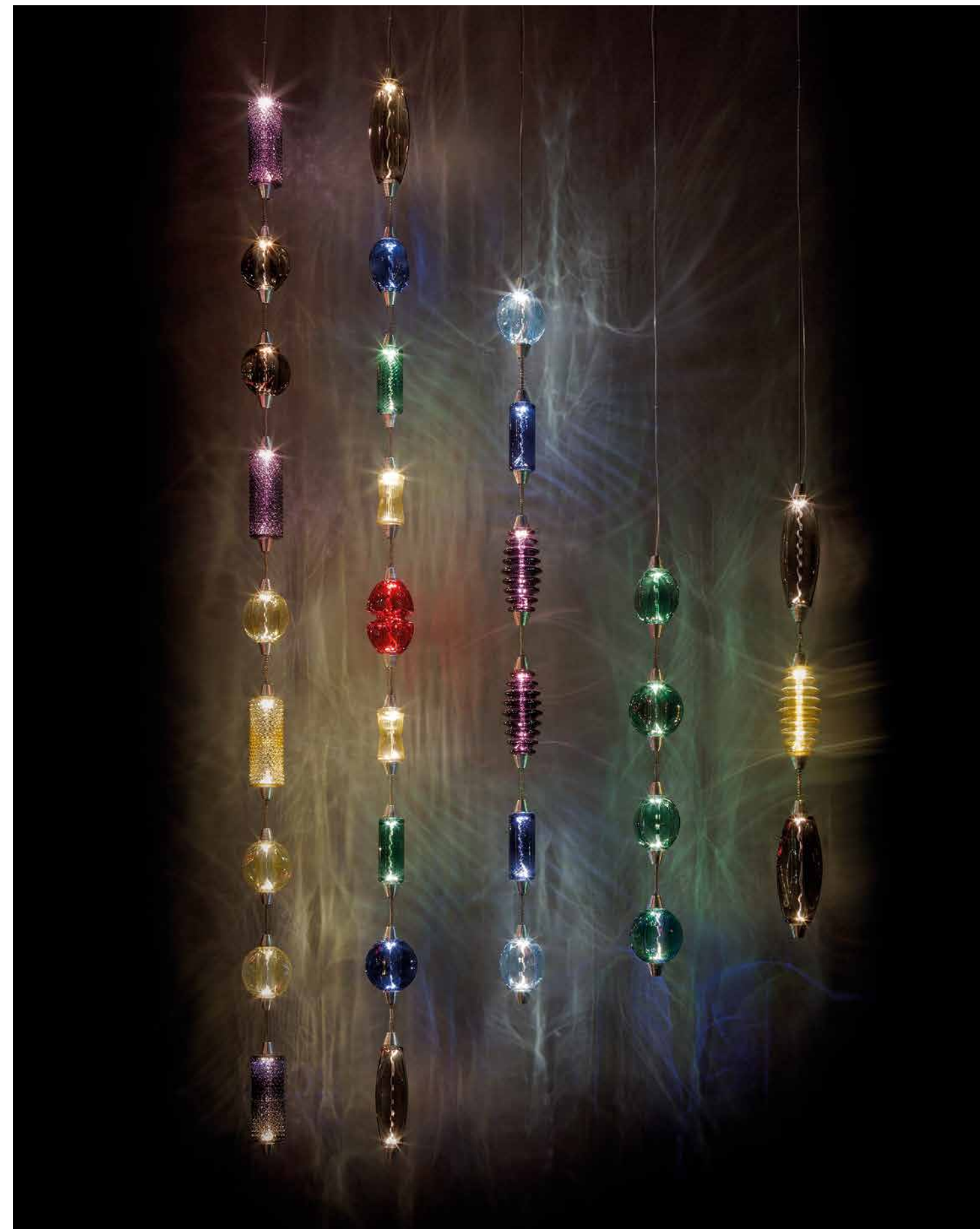
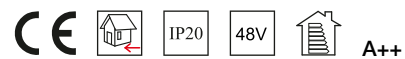

COLLIER
T1800/S8

DESIGNER
MARC SADLER



sospensioni _ suspensions

COLLIER T1800/S8

DESIGNER
MARC SADLER

: Innovativo sistema modulare disegnato da Marc Sadler per Itlamp, costituito da diverse forme e colori che offre la possibilità di innumerevoli composizioni. In foto: composizione a una fila e otto elementi in colore diamante.

: Innovative modular system designed by Marc Sadler for Itlamp, consisting in blown glass elements in different shapes and colours, offering countless combination possibilities. Photo: one line composition and eight elements in diamond glass.



dimensioni _ dimensions
L 230 h. 140 _ W 90" h. 55"

lampadine _ bulbs
48W LED - 5600 Lumen

3000K standard, alternativa disponibile a richiesta.
3000K standard, other options available on request.



— sospensioni _ suspensions

COLLIER T1800/L3

DESIGNER
MARC SADLER



sospensioni _ suspensions

COLLIER T1800/L3

DESIGNER
MARC SADLER

: Innovativo sistema modulare disegnato da Marc Sadler per Itlamp, costituito da diverse forme e colori che offre la possibilità di innumerevoli composizioni. In foto: composizione a una fila e dodici elementi in colore diamante e rubino.

: *Innovative modular system designed by Marc Sadler for Itlamp, consisting in blown glass elements in different shapes and colours, offering countless combination possibilities.*
Photo: one line composition and twelve elements in diamond and ruby glass.

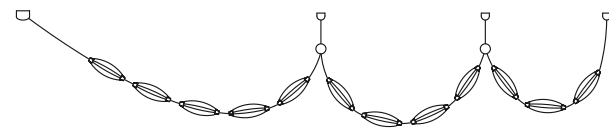

dimensioni _ dimensions
L 580 h. 120 _ W 228" h. 47"

lampadine _ bulbs
72W LED - 8400 Lumen

3000K standard, alternativa disponibile a richiesta.
3000K standard, other options available on request.



COLLIER T1800/SC

DESIGNER
MARC SADLER

: Innovativo sistema modulare disegnato da Marc Sadler per Italamp, costituito da diverse forme e colori che offre la possibilità di innumerevoli composizioni. In foto: composizione a tre file e venticinque elementi in colore diamante, acquamarina, zaffiro e smeraldo.

: Innovative modular system designed by Marc Sadler for Italamp, consisting in blown glass elements in different shapes and colours, offering countless combination possibilities.
Photo: three line composition and twenty five elements in diamond, aquamarine, sapphire and emerald glass.

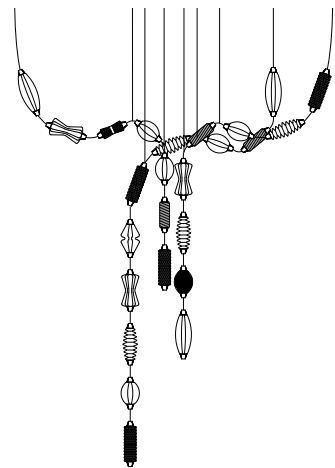

dimensioni _ dimensions
Ø246 h. 380 _ Ø 97" h. 149"

lampadine _ bulbs
150W LED - 17500 Lumen

3000K standard, alternativa disponibile a richiesta.
3000K standard, other options available on request.



— sospensioni _ suspensions

COLLIER T1800/T

DESIGNER
MARC SADLER



COLLIER T1800/T

DESIGNER
MARC SADLER

: Innovativo sistema modulare disegnato da Marc Sadler per Itlamp, costituito da diverse forme e colori che offre la possibilità di innumerevoli composizioni. In foto: composizione a tre file in colore diamante, acquamarina, zaffiro e smeraldo.

: *Innovative modular system designed by Marc Sadler for Itlamp, consisting in blown glass elements in different shapes and colours, offering countless combination possibilities.*
Photo: three line composition in diamond, aquamarine, sapphire and emerald glass.

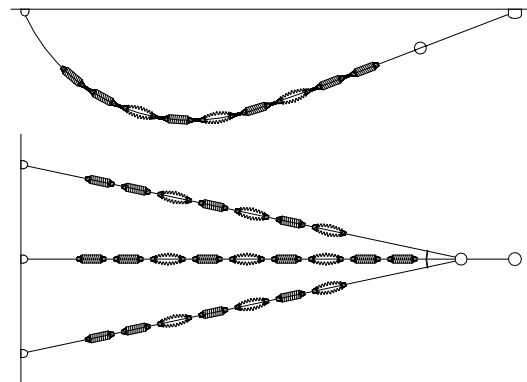

dimensioni _ dimensions

L500x180 h. var _ W 197"x71" h. var

lampadine _ bulbs

138W LED - 16100 Lumen

3000K standard, alternativa disponibile a richiesta.

3000K standard, other options available on request.



COLLIER T1800/S

DESIGNER
MARC SADLER

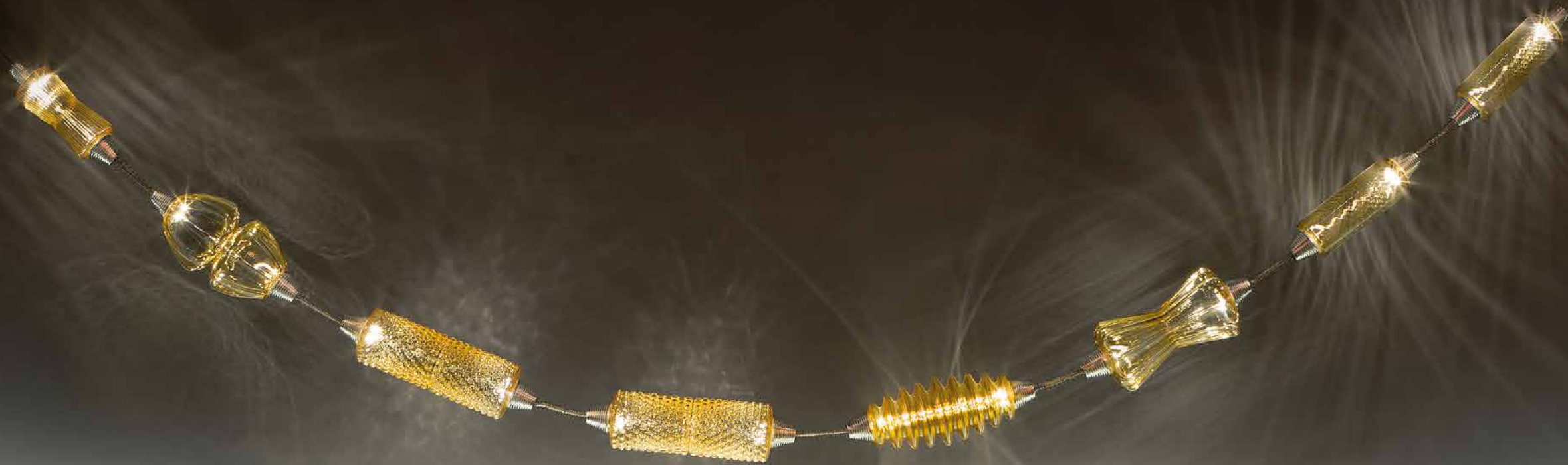

sospensioni _ suspensions

COLLIER T1800/S

DESIGNER
MARC SADLER

: Innovativo sistema modulare disegnato da Marc Sadler per Italamp, costituito da diverse forme e colori che offre la possibilità di innumerevoli composizioni. In foto: composizione a una fila in colore topazio.

: Innovative modular system designed by Marc Sadler for Italamp, consisting in blown glass elements in different shapes and colours, offering countless combination possibilities. Photo: one line composition in topaz glass.

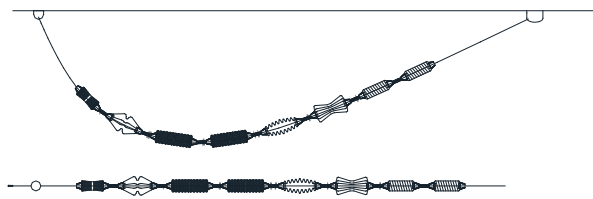

dimensioni _ dimensions
ø15 L.342 _ ø 6" W.135"

lampadine _ bulbs
48w - LED - 5600 Lumen

3000K standard, alternativa disponibile a richiesta.
3000K standard, other options available on request.

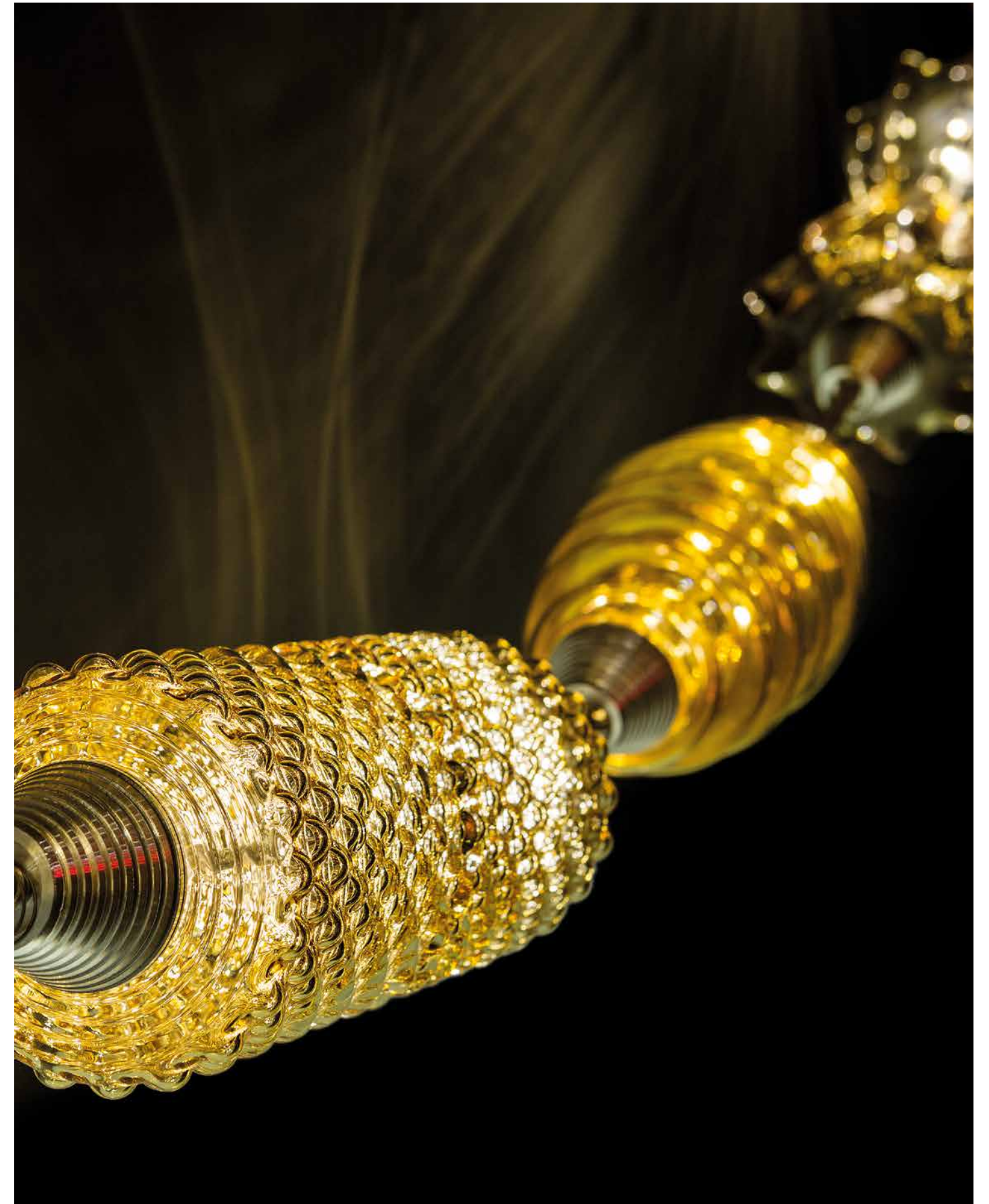
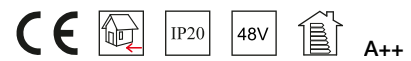

COLLIER T1800/R

DESIGNER
MARC SADLER

: Innovativo sistema modulare disegnato da Marc Sadler per Italamp, costituito da diverse forme e colori che offre la possibilità di innumerevoli composizioni. In foto: composizione a sei file, in colore diamante e rubino.

: Innovative modular system designed by Marc Sadler for Italamp, consisting in blown glass elements in different shapes and colours, offering countless combination possibilities. Photo: six lines composition in diamond and ruby glass.

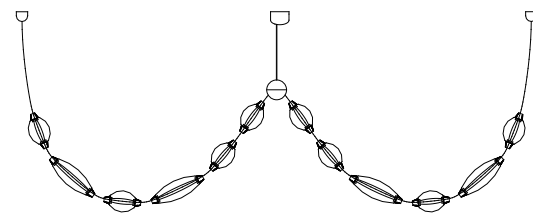

dimensioni _ dimensions
ø370 h. 190 _ ø 146" h. 75"

lampadine _ bulbs
216W LED - 25300 Lumen

3000K standard, alternativa disponibile a richiesta.
3000K standard, other options available on request.

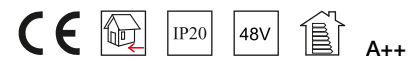

Ogni prodotto Italamp è corredato di una documentazione contenente tra l'altro il certificato di autenticità e la scheda di collaudo. In caso di reclamo il cliente dovrà sempre fornire copia della scheda. Sulla scheda sono contenute anche le istruzioni per un corretto montaggio dell'articolo. Italamp non risponde per eventuali danni a persone o cose causati da una non corretta installazione dei propri apparecchi di illuminazione, da un uso di lampadine non conformi e dalla modificazione delle caratteristiche tecnico costruttive.

La ditta si riserva di apportare ai modelli ogni modifica estetica e tecnica che a suo insindacabile giudizio ritenga necessaria.

Il marchio **CE** è un marchio europeo di garanzia che certifica la qualità del prodotto e la sua rispondenza ai parametri di sicurezza previsti dalle normative CEE.

Italamp può fornire per la quasi totalità dei suoi articoli la certificazione con marchio UL. In tutto il mondo UL testa prodotti secondo i requisiti di sicurezza statunitensi per un accesso sicuro ovunque nel Nord America.

UNI EN ISO 9001/2015 certifica in maniera stabile l'alta qualità e la grande affidabilità di tutti i processi produttivi aziendali della produzione Italamp. Italamp è un marchio registrato. Tutti i nostri modelli sono depositati e quindi coperti da brevetto.

Questo catalogo è tutelato dalla legge sui diritti d'autore (legge 22/4/1941 n°633 e dalla legge 14/12/1942 n°1485).

È vietata ogni riproduzione anche parziale dello stesso.

Each item is equipped with its own documentation including a certificate of authenticity and a card with instructions for quality control inspections. In case of complaint the customer should send us a copy of this card, which also contains instructions for correct assembling of the fixture.

Italamp is not liable for incidental injuries or damage to people or things due to: incorrect installation of the fixtures, use of not suitable bulbs, modification of the original technical features of the items.

The company has the right to modify any model for both aesthetic and technical features when necessary, according to Italamp's unquestionable judgement.

The label **CE** is a European guaranteed mark. It certifies product quality and its compliance with the safety standards stated by EEC regulations. Italamp can provide for most of its products the UL certification.

Worldwide, UL tests products according to U.S. safety requirements for secure access anywhere in north U.S.

UNI EN ISO 9001/2015 steadily certifies the high quality and the great reliability of all Italamp production processes.

Italamp is a registered trademark. All our items are registered and covered by patent.

This catalogue is copyrighted and protected by the Italian law (22/4/1941 n°633 and 14/12/1942 n°1485).

Any reproduction of this catalogue is strictly forbidden.

PRODUCED BY
ITALAMP s.r.l.

ALL RIGHTS RESERVED

No part of this publication may be reproduced or transmitted in any form or by any means, electronic or mechanical, including photocopying, recording or any information storage and retrieval system, without permission in writing from publisher.

PROJECT DIRECTOR: Danilo De Rossi, Roberta Vitadello, Stefano Traverso

GRAPHIC PROJECT: Stefano Traverso

PHOTOGRAPHERS: Studio Pointer

PRINTED:

ITALAMP

ITALAMP s.r.l.

Via Fermi,8 - 35010 Cadoneghe (PD) - ITALY

T. +39 049 8870442 - F. +39 049 8870418

italamp.com - info@italamp.com